



Development of managed functional network
method for organizing a man-machine dialogue
in automated systems

Evgeniy Lavrov, Natalia Barchenko and Olga Lavrova

EasyChair preprints are intended for rapid
dissemination of research results and are
integrated with the rest of EasyChair.

December 29, 2020

Development of managed functional network method for organizing a man-machine dialogue in automated systems

Evgeniy Lavrov
Sumy State University
Sumy, Ukraine
prof_lavrov@hotmail.com

Natalia Barchenko
Sumy National Agrarian University
Sumy, Ukraine
barchenkonatalia@gmail.com

Olga Lavrova
Taras Shevchenko National University
of Kyiv
Kyiv, Ukraine
lavrova_olia@ukr.net

Abstract—In the article the authors substantiate the necessity for improvement of adaptation mechanisms in man-machine systems. They set a task of optimizing the man-machine interaction; describe the use of functional networks for ergonomic design tasks' solution. There are introduced the concepts of "controlled functional network" and "neural functional network", the principle of multi-stage optimization of man-machine interaction. The offered method differs from the existing ones: 1.by interconnecting functional and neural networks; 2. by the possibility of multiple (in the course of work) adaptation (optimization) of the system "tailored to a man", which provides properties of adaptive man-machine interaction.

Keywords—automated system, man-machine interaction, adaptation, ergonomics, functional network, neural network, functional comfort, optimization

I. INTRODUCTION

In modern automated systems, there are big problems related to human factors and the need to adapt to the peculiarities of a human-operator, depending on the state of the control object and environmental parameters [1-3].

Despite the huge amount of work, including ergonomics-related methods [4, 5], the creation of intelligent agents [1,5, 6], the issues of flexible responsiveness of the computer systems on the human parameters are not fully resolved.

II. STATEMENT OF THE TASK

The task of the research is to develop an approach to the creation of models that allow the analysis of objective quantitative characteristics of the human-operator and the technology of his interaction with means of automation:

- Predict the time-reliable results of activities;
- Carry out, in the process of all activities (at the control points), the choice of the most appropriate options for man-machine interaction

III. RESULTS

A. Principle of description and assessment structures of human-machine dialogue

Simulation of elementary actions of operators and automatics is carried out using typical functional units (TFU). The most common of these are the "work operation" with the designation "rectangle", "control operation" with the designation "circle", and "alternative operation" with the designation "rectangle with several outputs". A complete description of TFU models is given in [8-10]. The FN that describes the algorithmic activity of the human operator is

built from those TFU. Examples of models (accuracy and run-time estimation) for some typical functional structures (TFS) are shown in Table 1.

TABLE I. EXAMPLES OF TYPICAL FUNCTIONAL STRUCTURES*

Content of typical functional structure	TFS diagram	Index	Formula for computation
1.Consistent implementation of operations		Probability of error-free operation	$B = \prod_{i=1}^n B_i$
		Expectation value of the time of operation	$M(T) = \sum_{i=1}^n M(T_i)$
		Dispersion of the time of operation	$D(T) = \sum_{i=1}^n D(T_i)$
2.Cyclic functional structure "An operation with action control without restrictions on the number of cycles"		Probability of error-free operation	$B = B^1 * K^{11} * \frac{1}{1 - (B^1 * K^{10} + B^0 * K^{00})}$
		Expectation value of the time of operation	$M(T) = (M(T_p) + M(T_k)) * M(L)$ $M(L) = \frac{1}{1 - (B^1 * K^{10} + B^0 * K^{00})}$
		Dispersion of the time of operation	$D(T) = D(T) * (M(T_p) + M(T_k))^2 + (D(T_p) + D(T_k)) * M(L)$ $D(L) = \frac{B^1 * K^{10} + B^0 * K^{00}}{(1 - (B^1 * K^{10} + B^0 * K^{00}))^2}$
3. Functional structure "An operation with action control and without restrictions on the number of cycles"		Expectation value of the time of operation	$B = B_1^1 * K^{11} + (B_1^0 * K^{00} + B_1^1 * K^{10}) * B_2^1$
		Expectation value of the time of operation	$M(T) = M(T_{p1}) + M(T_k) + (B_1^0 * K^{00} + B_1^1 * K^{10}) * M(T_{p2})$
		Dispersion of the time of operation	$D(T) = D(T_{p1}) + D(T_k) + (B_1^0 * K^{00} + B_1^1 * K^{10}) * D(T_{p2}) + (B_1^0 * K^{00} + B_1^1 * K^{10}) * (B_1^1 * K^{11} + B_1^0 * K^{01}) * M^2(T_{p2})$

* - Subscripts in formulas correspond to the type (operating course – p; course of control – k) and / or to the number of TFU.

Here:

B^l - the probability of error-free handling operation;

K^{ll} - the probability of recognizing the correct operations performing;

K^{oo} - the probability of detecting any errors;

$M(T)$ - mathematical expectation of the operational run-time;

$D(T)$ - the variance of the operational run-time.

These models are used to evaluate the entire functional network (FN) that describes the man-machine interaction algorithm. The reliability and runtime estimation is carried out by the method of reduction FN [8-10].

For the evaluation of human-computer interaction has developed special software systems [11].

B. Analysis of multivariate process of man-machine interaction

Man-machine interaction consists of a sequence of steps. At each step, there are many possible ways both to implement the main technologically necessary operations and to monitor and correct errors[12-17]. A multiplicity of options (excerpt) is shown in Figure 1.

C. Formulation of the optimization problem of man - machine interaction

The problem can be formulated as follows:

$$f_k(X) \rightarrow \max \quad (1)$$

$$\beta(X) \rightarrow \max \quad (2)$$

$$P\{T(X) < T_o\} > \alpha \quad (3)$$

$$X \in X_o \quad (4)$$

where X_o – a set of alternative options for the algorithm of activities;

$\beta(X)$ – the probability of error-free implementation of the algorithm of activities;

T – random variable time implementation algorithm of activities;

T_o – scheduled time of performance;

α – minimum allowable probability of timely completion;

$f_k(X)$ - the degree of functional comfort,

X – a vector characterizing the alternative structure of human-computer interaction.

D. The method of controlled functional network. The general scheme. The principle of integration of functional and neural networks

To implement procedures of the FN “control”, we offer the idea of interconnecting neural and functional networks for modeling HMS, which the authors proposed in their work [11,18] before. Probabilistic characteristics of human work elements, which are used as input data to the models of the

operation algorithms, can be represented as neural models, displaying these characteristics depending on various factors.

E. The general scheme. The principle of integration of functional and neural networks.

According to this approach and taking into account the changing characteristics of the human-operator and the environment, a neural network (NN) D-network is created for each element of the functional network (Figure 2). The purpose of D-network is to provide FN with relevant source data. D-network is constructed for each case according to the requirements of the designer.

The following characteristics of the human-operator [10] may be input parameters for NN:

- training;
- type of nervous system;
- functional state;
- motivation;
- emotional stress level and others.

Output parameters of NN include:

- the probability of error-free operation (algorithm);
- expectation time of the operation (algorithm);
- intensity of operator’s activity and others.

Let us consider the example of a model, constructed for the problem of fore-casting the results of a computer-aided instruction system. Suppose, for example, one must take into account the individual characteristics of a person and to adapt the system, at each step, to him.

There are, for example, such options (alternatives) of learning algorithm:

- a) The sequence of operations without control.
- b) The sequence of operations controlled after each operation.
- c) The sequence of operations with the final control in the end.
- d) The sequence of operations with functional control.

We need to select the most suitable mode of learning, taking into account the individual characteristics of the trainee, his goals and the importance of the criteria To solve this problem, we form and train the A-network. Let A-network input be data from the model of the human-operator, then the network output falls into the recommended mode.

F. Adaptation points. Incremental methods of decision-making

Parameters of a man and an environment, unfortunately, are not permanent and dynamically change over time. Moreover, the selected mode of interaction cannot be sufficiently effective in this case. Therefore, there is a need for periodic assessment of the situation and making adjustments in the process of interaction. Under adjustments we understand algorithm change interaction.

To do this, we add point adaptation (Figure 2) into the learning process to provide control at each point and, if necessary- the reconstruction of the network.

Depending on the availability of input data, a decision-making at points of adaptation may be carried out, using:

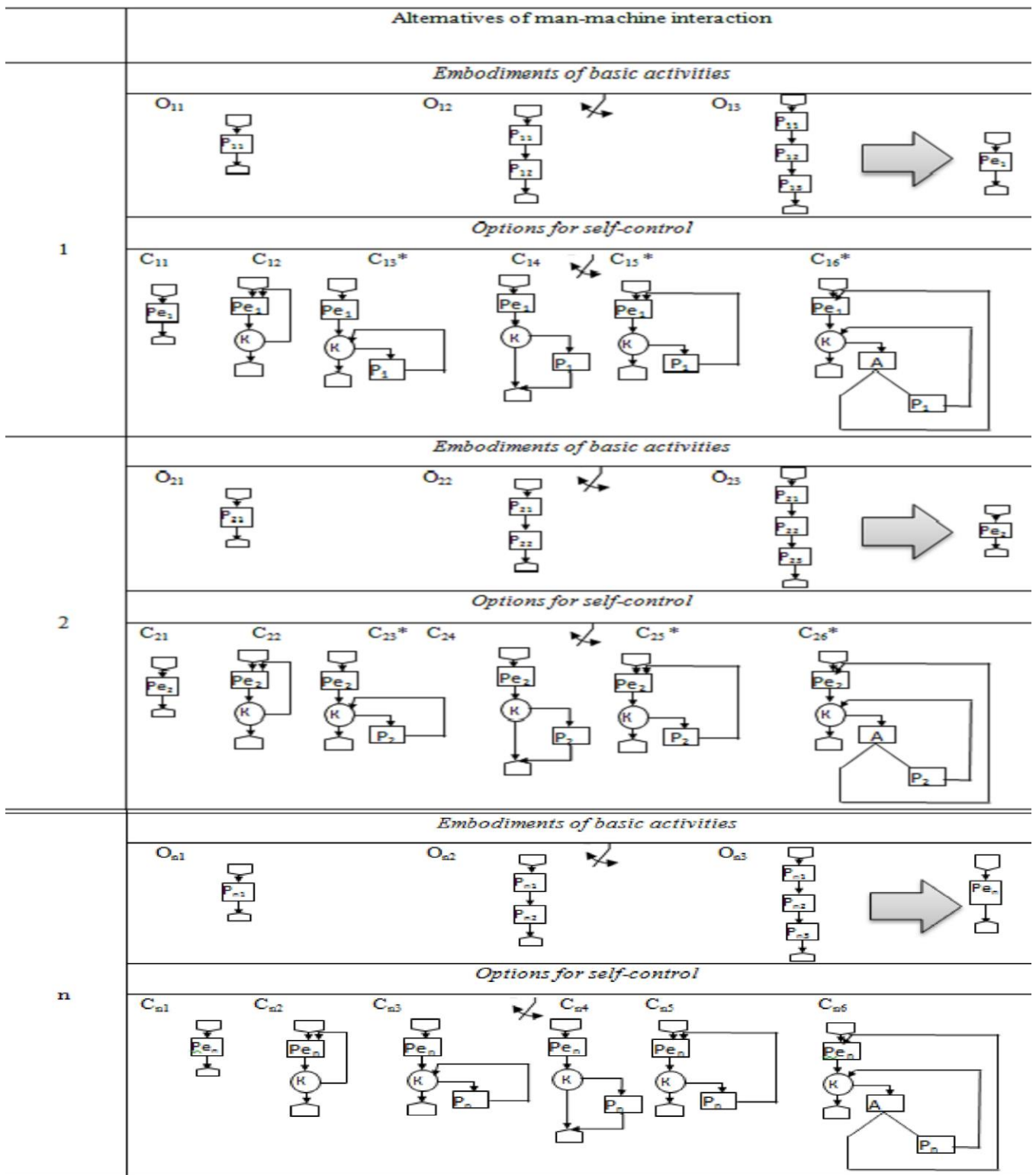
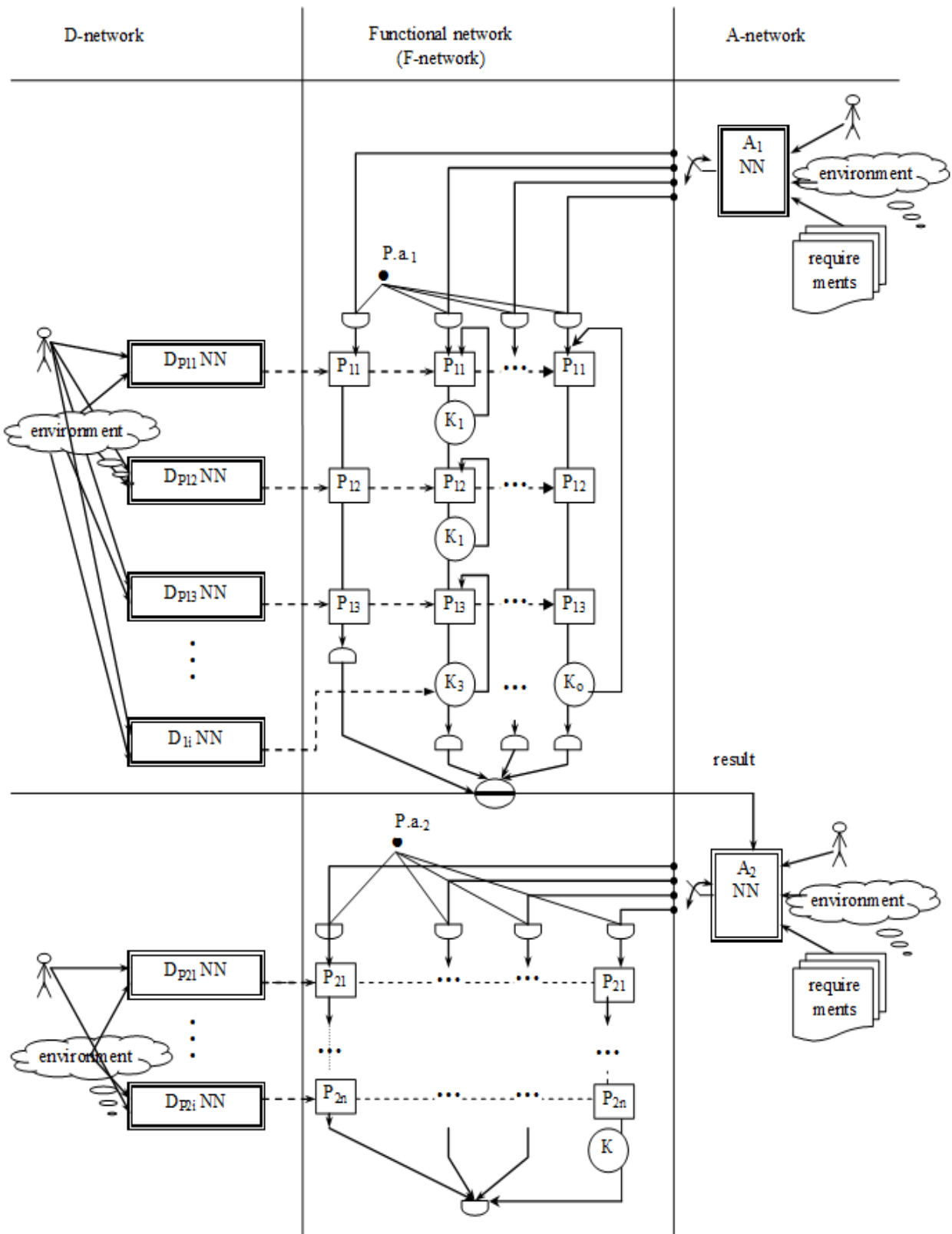





Fig. 1. Demonstration of multiple versions of man-machine interaction (n - number of of steps)



.Fig. 2. The principle of controlled functional network

-  - step of the functional network;
-  - operation of functional control;
-  - neural network;
-  - initial data about the quality of the operation;

$P.a.i$ - point of adaptation № i ($i = \overline{1, n}$, where n - number of points of adaptation).

- neural network (A-network) [7,19];
- models of fuzzy logic [7,19];
- mathematical programming models used in functional networks [19-23].

Thus, the problem is reduced to the multiple implementation of the optimization problem of (1) - (4) types.

G. Data storage

A concept can work only subject to the organization of a special data storage [11,18]:

H. Testing. Application in practice of mathematical models. Computer system for adaptation of man-machine interaction..

Given approach has been tested in the technology of the intelligent agents for e-learning [18](Fig.3).

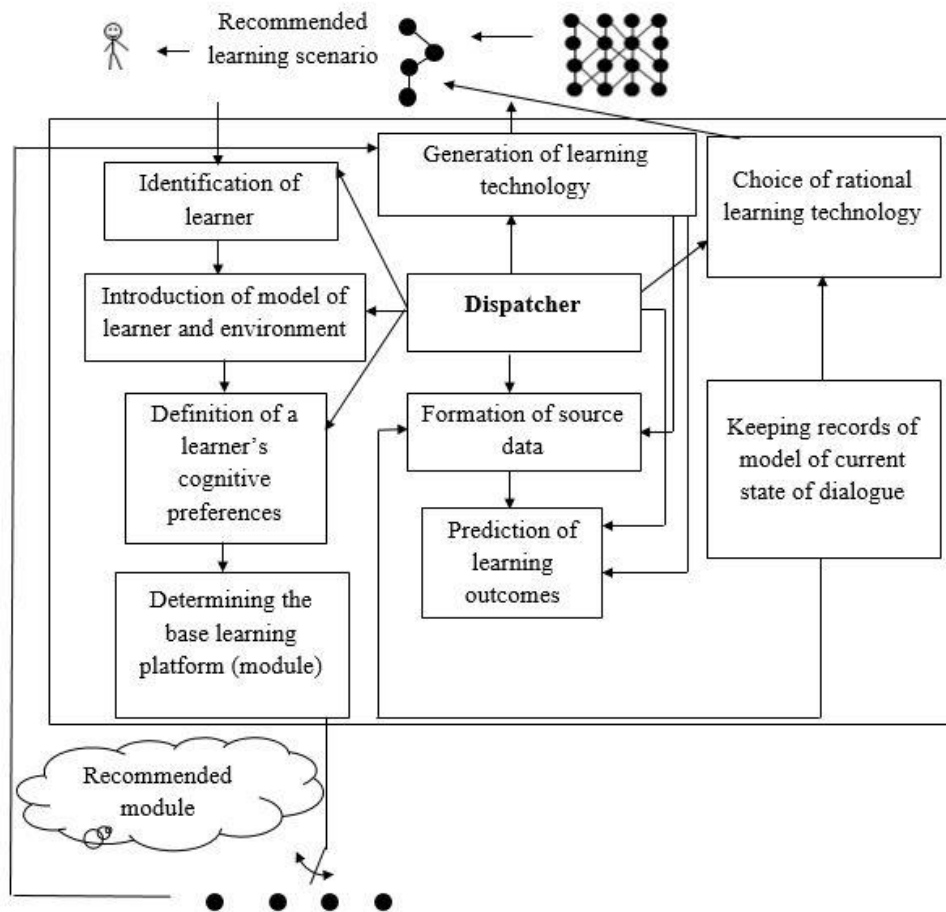

Fig. 3. The principle of the agent-manager for e-learning.

The neural-functional network uses data from all university databases and manages the human-computer dialogue. The computer program performs the following actions:

1. analyzes data on previous sessions of training (for this student and other students);
2. forms several neural networks to predict the time and accuracy of the electronic educational module (for a given student and for given learning conditions);
3. selects a neural network that provides minimal error for the prediction results;
4. builds a model of the process of dialogue (in the form of a functional network);
5. enters initial data for a particular student into the dialogue process model;
6. assesses the accuracy and time of activity for this student, taking into account the motivation and time that is available,

as well as taking into account the functional state of the human operator;

7. forms tips for the student (which electronic training module to choose, how to carry out monitoring activities, etc.);
8. analyzes current progress and correcting recommendations for the student.

A computer program that is controlled by a neural-functional network performs all of these actions for all possible control points by dialogue.

The results were embedded in:

- Moscow State University. M.V. Lomonosov,
- Belgorod Agrarian Academy,
- Sumy National Agrarian University,
- Sumy State University;
- Vinnytsia State Agrarian University,

- Ukrainian Engineering and Pedagogical Academy (Kharkov),
- and other universities.

The use of the agent-manager allowed the experimental group (Sumy National Agrarian University) to raise the average score from 72.32 to 81.43 and reduce the percentage of refusal to work with e-learning from 24.78% to 7.29%.

CONCLUSION

Man-machine interaction in discrete automated systems can be well described using models, based on functional networks. Adaptive changes in man-machine interaction can be reduced to the problem of step-by-step choosing the optimal fragment of the functional network. The method

REFERENCES

- [1] Rothmorea, P. The implementation of ergonomics advice and the stage of change approach [Text] / P. Rothmorea, P. Aylwardb, J. Karnon // *Applied Ergonomics*. 2015. – V. 51. – P. 370–376. doi: 10.1016/j.apergo.2015.06.013
- [2] Cacciabue, P. C. Human error risk management for engineering systems: a methodology for design, safety assessment, accident investigation and training [Text] / P. C. Cacciabue // *Reliability Engineering & System Safety*. 2014. – V. 83(2). – P. 229 – 269. doi: 10.1016/j.res.2003.09.013
- [3] Dul, J. A Strategy for human factors/ergonomics: developing the discipline and profession [Text] / J. Dul, R. Bruder, P. Buckle, P. Carayon, P. Falzon, W. S. Marraset // *Ergonomics*. 2012. – V. 55(4). – P. 377–395. doi: 10.1080/00140139.2012.661087
- [4] Bentley, T. A. The Role of organisational support in teleworker wellbeing: A socio-technical systems approach [Text] / T. A. Bentley, S. T. T. Teo, L. McLeod, F. Tana, R. Bosua, M. Gloet // *Applied Ergonomics*. 2016. – V.52. – P. 207–215. doi: 10.1016/j.apergo.2015.07.019
- [5] De Felice, F. Methodological Approach for Performing Human Reliability and Error Analysis in Railway Transportation System [Text] / F. De Felice, A. Petrillo // *International Journal of Engineering and Technology*. 2011. – V. 3(5). – P. 341–353.
- [6] Burov, O. Ergonomic evaluation of e-learning systems [Text] / O. Burov, O. Tsarik // Presented at Zastosowania Ergonomii, Poland, 2013.
- [7] Sedov, V.A. The fuzzy model of ships collision risk rating in a heavy traffic [Text] / V.A.Sedov, N.A.Sedova, S.V.Glushkov// In Proc. of the 22nd International Conference on Vibroengineering. 2016. – P. 453–458.
- [8] Adamenko, A.N., Asherov, A.T., Berdnikov, I.L. et al. Information controlling human-machine systems: research, design, testing, Reference book, Gubinsky, A.I. & Evgrafov, V.G., eds., Mechanical Engineering, Moscow, 1993. -528 p. (In Russian)
- [9] Popovich, P.R. Ergonomic support of astronauts' activities /P.R. Popovich, A.I. Gubinskiy, G.M. Kolesnikov.-M.: Mechanical Engineering, 1985.-272p. (In Russian)
- [10] Chabanenko, P.P. Research of the safety and efficiency of the functioning of systems “human – technics” by ergonomic networks /P.P. Chabanenko.- Sevastopol, Academy of naval forces named after P. S. Nahimov, 2012.-162p. (In Russian)
- [11] Lavrov, E. Computer Simulation of Discrete Human-Machine Interaction for Providing Reliability and Cyber-security of Critical Systems[Text] / E. Lavrov, A. Volosiuk, N. Pasko, V. Gonchar , G.Kozhevnikov // Proceedings of the Third International Conference Ergo-2018: Human Factors in Complex Technical Systems and Environments (Ergo-2018) July 4 – 7, 2018, St. Petersburg Russia-2018.-P.67-70
- [12] Anokhin, A. Education and professional development of ergonomists in Russia [Text] / A. Anokhin, I. Gorodetskiy, V. Lvov, P. Paderno // In Proc. of International Conference in Applied Human Factors and Ergonomics 2014 and the Affiliated Conferences, 2014. – P. 1017–1024.

adapts the system to the peculiarities of the human-operator and environmental parameters.

The combined model, which consists of a neural network for forming initial data, a functional network for modeling a dialogue and a neural network for managing the dialogue process provides a higher level of adaptation to a human operator than the known models built on the basis of unmanaged functional networks. The computer program was used in the design process for systems of various purposes and its effectiveness was shown. Experimental studies have shown the constructiveness of the developed method. Models will be useful for automated control in industry, agriculture and e-learning.

- [13] Tortorella, G. L. Lean manufacturing implementation: an assessment method with regards to socio-technical and ergonomics practices adoption [Text] / G. L. Tortorella, L. G. L. Vergara, E. P. Ferreira // *The International Journal of Advanced Manufacturing Technology*. 2016. – P. 1–12.
- [14] Lavrov, E. Ergonomics of IT outsourcing. Development of a mathematical model to distribute functions among operators [Text] / E. Lavrov, N. Pasko, A. Krivodub, N. Barchenko, V. Kontsevich // *Eastern European Journal of Enterprise Technologies*. 2016. – N.4 (80). – P. 32-40.
- [15] Yang, J., Yang, M., Wang, W., and Li, F. Online application of a risk management system for risk assessment and monitoring at NPPs. *Nuclear Engineering and Design*, vol. 305, 2016.- P. 200-212.
- [16] Hassnain, A., Yu, Y., Shahzad, M. A., Ammar, M. A., and Ansari, T. Q. Available recovery time prediction in case of an accident scenario for NPP component. *Progress in Nuclear Energy*, vol. 97, 2017.- P. 115-122.
- [17] Xu, P., Wang, J., Yang, M., Wang, W., Bai, Y., and Song, Y. Analysis of operator support method based on intelligent dynamic interlock in lead-cooled fast reactor simulator. *Annals of Nuclear Energy*, vol. 99, 2017.- P. 279-282.
- [18] Lavrov, E. Development of Adaptation Technologies to Man-Operator in Distributed E-Learning Systems [Text] / E. Lavrov, N. Barchenko, N. Pasko, A. Tolbatov // *Proceedings of 2nd International Conference on Advanced Information and Communication Technologies-2017 (AICT-2017)*, Lviv, Ukraine, July 4-7, 2017.– P. 83-87
- [19] Lavrov, E. Management for the Operators Activity in the Polyergatic System. Method of Functions Distribution on the Basis of the Reliability Model of System States [Text] / E. Lavrov, N. Pasko, V.Borovyk// *International Scientific and Practical Conference«Problems of Infocommunications.Science and Technology»*, PICS&T, 2018.- P. 423-429
- [20] Lavrov, E. Mathematical models for the distribution of functions between the operators of the computer-integrated flexible manufacturing systems [Text] / E. Lavrov, N. Pasko, A. Krivodub, // In Proc. of the International Scientific Conference TCSET'2016, 2016. – P. 72–77.
- [21] Grif M. G. Methods of desingning and modeling of man–machine systems [Text] / M. G. Grif, O. Sundui, E. B. Tsoy // In Proc. of International Summer workshop Computer Science 2014, 2014. – P. 38–40.
- [22] Lavrov, E. Automation of Assessing the Reliability of Operator's Activities in Contact Centers that Provide Access to Information Resources/ E. Lavrov, N. Pasko // *Proceedings of the 14th International Conference on ICT in Education, Research and Industrial Applications. Integration, Harmonization and Knowledge Transfer. Volume I: Main Conference*, Kyiv, Ukraine, May 14-17, 2018.-P.445-448..
- [23] Lavrov, E. Management for the Operators Activity in the Polyergatic System. Method of Functions Distribution on the Basis of the Reliability Model of System States [Text] / E. Lavrov, N. Pasko, V.Borovyk// *International Scientific and Practical Conference «Problems of Infocommunications.Science and Technology»*, PICS&T, 2018.- P. 423-429