



## Analysis on Fault Location of TCSC Lines with Travelling Wave

---

Chur Hee Lee, Seung Wan Kim and Jong Su Yun

EasyChair preprints are intended for rapid dissemination of research results and are integrated with the rest of EasyChair.

September 5, 2019

# Analysis on Fault Location of TCSC Lines with Travelling wave method: Korean Case

Chur Hee Lee

National Generation T&S laboratory  
KEPRI  
Daejeon, Korea  
Churhee.lee@kepco.co.kr

Seung Wan Kim

Dept. of Electrical Engineering  
Chungnam National University  
Daejeon, Korea  
swakim@cnu.ac.kr

Jong Su Yun

National Generation T&S laboratory  
KEPRI  
Daejeon, Korea  
yoonjongsu@kepco.co.kr

**Abstract**—This paper deals with analysis on fault location of TCSC(Thyristor Controlled Series Capacitance) at the existing AC grid in Korea. The TCSC is firstly applied in Korea to compensate real power in case of 765kV line faults. However, we have some trouble detecting the exact fault location due to series capacitance. If we can precisely know the fault location, maintenance crews can reach there quickly and remove the fault as soon as possible. Therefore, precisely locating of the fault point on transmission lines is very important to improve the system reliability and to decrease economic damage as inherent consequence of long-term outages. In this paper, after making some contrade files with PSCAD/EMTDC and expressing on the XY graph, we will calculate the fault location using time difference between two ends of line. After analyzing with this method, we will adapt the contrade files into the real fault locator. After that, we will analyze errors between calculated results and real data given from the fault locator at fault locations. In conclusion, after verifying with the fault locator using the travelling wave method in TCSC lines, we will make an appeal to introduce into real substations in Korea.

**Keywords**—*fault location, travelling wave, TCSC(Thyristor Controlled Series Capacitance)*

## I. INTRODUCTION

TCSC (Thyristor controlled Series Capacitance) has not been applied in the Korean power system yet. Currently, four TCSC systems as depicted in Fig.1 are being installed on two substations at Shinjecheon and Shinyoungju. Korea Power Electric Corporation (KEPCO) will start those operations in this year. The TCSC has been proven to be an excellent solution because they can increase power transfer, enhance system stability, and mitigate the effects of sub-synchronous resonance (SSR) [1], [2]. The main reason to adapt the TCSC system in Korea is to maintain power system stability in conventional AC transmission lines in case of 765kV line faults. Additionally, this TCSC system is important in supporting continuous supply of electric power into the metropolitan area in Korea.

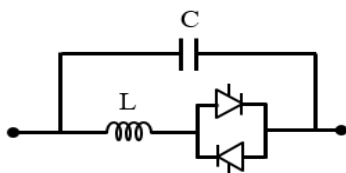

Fig. 1. Typical TCSC system

Fault locators can be used for identifying a fault location in a power transmission line [3]. The conventional technique such as impedance method and travelling wave technique are used for finding a fault location in case of transmission line fault [4]. However, it is not easy to adapt impedance based method because of physical problem using line PTs(Potential Transformers) at electrical substations and other reason that impedance may be changed from operations of series capacitances. For this reason, it is suggested in this paper that the travelling wave method is adapted to the fault locators for the transmission lines with the TCSC system.

In this paper, it is verified whether the fault locators using the travelling wave method can detect faults on the transmission lines with the TCSC system. Firstly, we studied theoretical background on the travelling wave method in case of AC faults compared with faults detection scheme by the impedance method. The AC transmission lines with the TCSC system are modeled with PSCAD/EMTDC, and after that the practical data from field tests is compared to the simulation results.

## II. TYPICAL FAULT LOCATION METHODS

### A. Impedance method for fault location

The impedance method has been usually considered as economic and convenient way of detecting faults. The algorithm of this method is simple and does not need communication channel or remote data. This method needs to measure voltage and current at one side and calculate apparent power. To succeed in detection of fault location like Fig.2, phase-to-phase voltage and phase current must be measured.

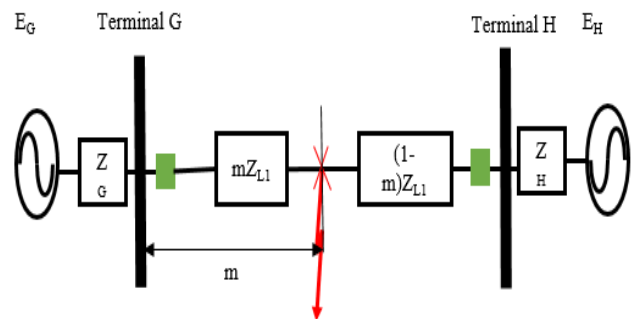

Fig. 2. One-line Diagram of a Two-terminal Transmission Network

If zero sequence exists, we can calculate fault location in case of phase to ground fault. The distance to fault is calculated from the following equation (1) from [5]:

$$x = \frac{\text{Im}\left(\frac{V_A}{I_A + K_0 + I_F}\right)}{\text{Im}(Z_L)} \quad (1)$$

where  $V_A$  and  $I_A$  indicate measured voltage and current at the sending line, and  $K_0 = (Z_{OL} - Z_{1L}) / 3Z_{1L}$ .  $\text{Im}$  indicates imaginary part of some values.  $Z_{OL}$  and  $Z_{1L}$  indicate zero sequence value and positive sequence value of all of one line.  $Z_L$  is positive sequence value per unit length.

### B. Travelling wave method for fault location

The travelling wave method uses not only fundamental frequency, but also harmonic components for inlet signal in case of faults. This method should study with single line by Vitin [6]. Fault distance can be calculated from time difference of forward wave(S1) and backward travelling wave(S2). When calculating fault distance, we need to check arrive time at the detection area with the time delay of backward travelling wave after forward wave arrives [7].

The fault calculation process starts when the detector senses the forward fault signal. Failure judgment at the front can be achieved when S1 signal exceeds the threshold value. Fig. 3 indicates the first incident wave as reflective wave at discontinuous buses is going to the fault location after detecting point. At this moment, signal S1 will have above a set reference value, but S2 value will not be changed.

The time that the maximum value of the discrete correlation function is displayed with indications of the time when the forward wave is returned from the fault point, leaving the relay point.

Therefore, the distance to fault point from the detected point is expressed from the following function (2).

$$x = \frac{\tau}{2} \times v \quad (2)$$

where  $x$  indicates the distance from the measurement point to the fault point,  $v$  is propagation velocity, and  $\tau$  indicates time with maximum value of discrete correlation function.

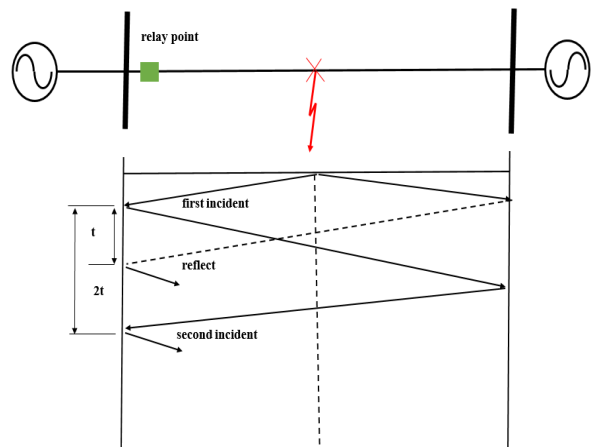

Fig. 3. Lattice diagram

### III. PSCAD/EMTDC MODELING

Fig.4 is PSCAD/EMTDC modeling of Shinyongju-Hanul 345kVline with TCSC. This was made up to simulate fault situations at 0%, 40%, 60%, 100% fault locations based on ABB TCSC model. The most important thing is that sampling frequency should be set to 1MHz, because travelling wave can be detected at high frequency. Fig 5 is showing A phase fault at 0% location.

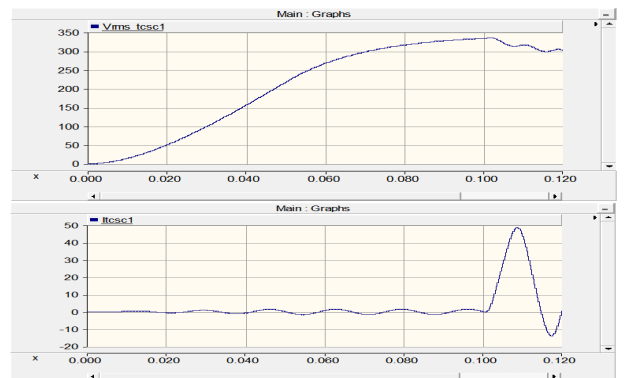

Fig. 5. Vrms and I waveform at 0% Shinjecheon-Donghae line location

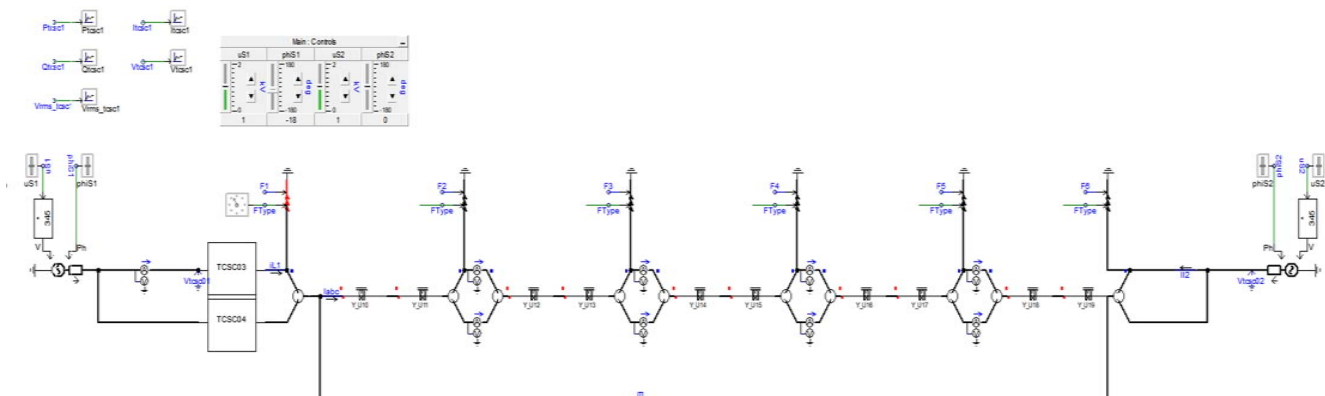

Fig. 4. PSCAD modeling of Shinjecheon-Donghae line

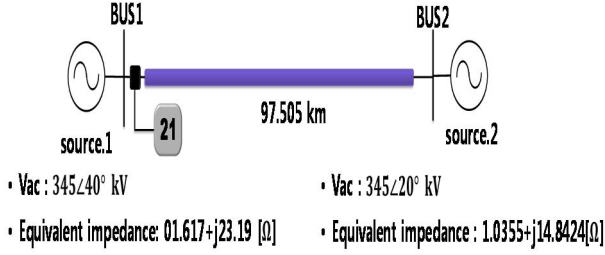

Fig. 6. Equivalent AC line for simulation of Shinjecheon-Donghae line

TABLE I. IMPEDANCE OF SHINJECHON-DONGHAE AC LINE

	Parameter	Value	Unit
Positive & Negative	R1, R2	0.01755	$\Omega/km$
	XL1, XL2	0.30571	$\Omega/km$
	XC1, XC2	190.74557	$M\Omega \cdot m$
Zero	R0	0.17313	$\Omega/km$
	XL0	0.84679	$\Omega/km$
	XCO	572.23671	$M\Omega \cdot m$

Before simulation, we set this line like Fig.6 and Table I. The length of this line is 97.505km, and the line voltage is 345kV. The equivalent impedance at both end sides was given from E-tran program. Impedance of this line is like table I.

If fault happened at 0% location, the position from Shinjecheon substation is 0%, the position from Donghae substation is 100% in this line. We simulated as phase-to-ground fault at 0%, 40%, 60%, 100% positions to earn contrade files for real fault locator. Each end has current, voltage transformer to measure 3 phase currents and voltage. After that, we verified current and voltage waveform at XY coordinate program.

From Fig. 7 to Fig. 10 indicate voltage and current waveforms at 60% fault location in this line. These waveforms show us if contrade files are appropriate or not. Like figures, these waveforms exactly indicate one phase fault and similar fault time from both sides.

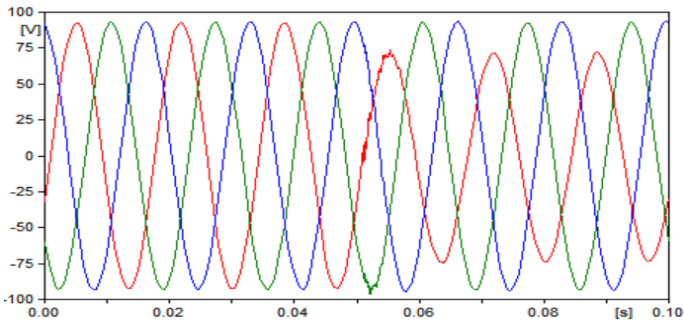

Fig. 7. Measurement voltage from Shinjecheon at 60% location of line

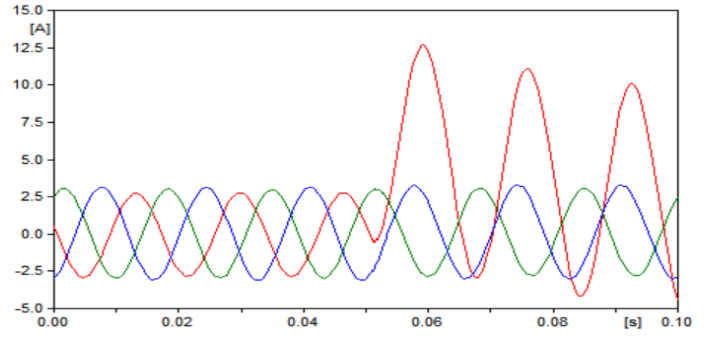

Fig. 8. Measurement current from Shinjecheon at 60% location of line

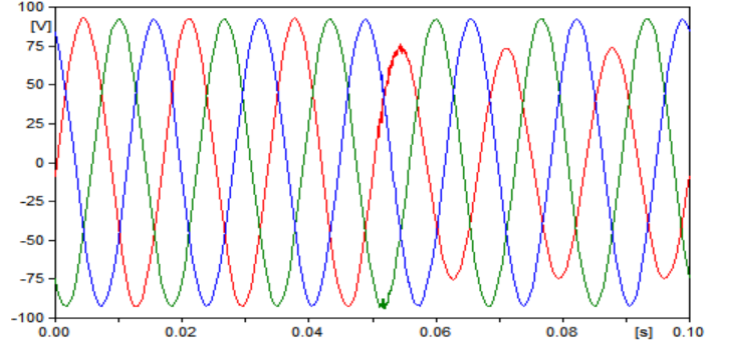

Fig. 9. Measurement voltage from Donghae at 60% location of line

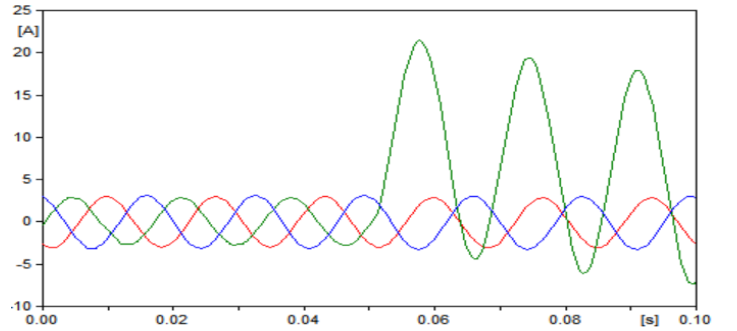

Fig. 10. Measurement current from Donghae at 60% location of line

#### IV. EXPERIMENT AT FAULT LOCATOR

It is a transmission wave method that injects a pulse generating circuit from a fault point detector to determine the failure distance based on the arrival time from the point of fault to reflect from the point of fault and return from the track terminal [7].

When a free charge is generated on any part of the track by a fault, the charge is divided into two groups, each of which is directed toward the transmission and the receiving end, forming a travelling wave [8].

The fault location can be simply calculated with equation (3), (4) from [9]. Equation (3) is for two fault locators at both bus, and equation (4) is for just one fault locator at one bus.

$$m = l/2[1 + (t_{L1} - t_R)]/TWLPL \quad (3)$$

$$m = l/2[1 + (t_{L2} - t_{L1})]/TWLPL \quad (4)$$

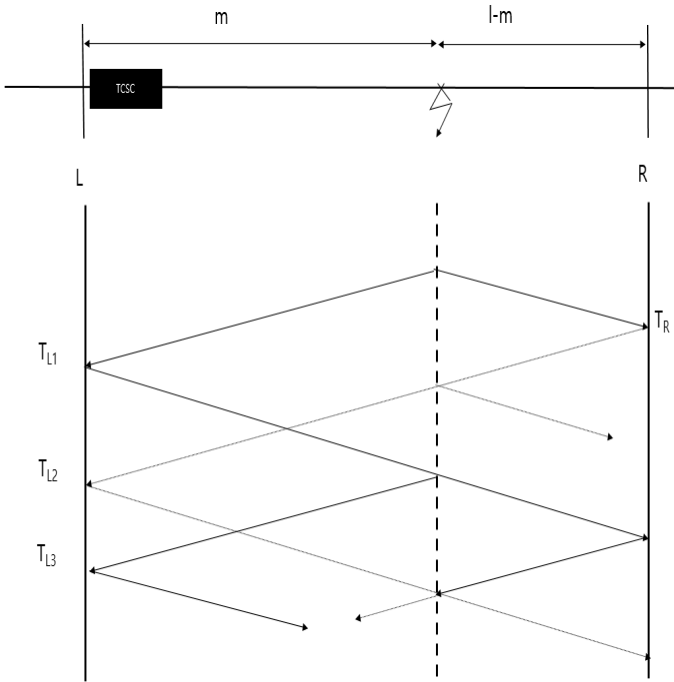

Fig. 11. Travelling wave characteristics at both ends

Where,  $m$  indicates distance from measurement point to fault point,  $l$  is line distance from BUS L and  $TWLPL$  indicates travelling wave velocity. The fault points can be easily calculated With equation 2 and 3. All lines are overhead lines.

## V. VERIFICATION WITH T400 FAULT LOCATOR

### A. Shinjecheon-Donghae line

From Fig.12 to Fig.15 show the current travelling waves from terminals Shinjecheon and Donghae associated with Phase A fault. The fault distances from Shinjecheon substation are at 0%, 40%, 60%, 100% location. Each distance is calculated from equation (3), (4).

The line distance is 97.510km, which has a little error compared with real distance because this relay considers TCSC system at each substation. First left pulse means the time when the travelling wave arrives at terminal Shinjecheon after fault. Fractional fault location represents expression by decimal point at the line fault point. Light propagation is the travelling-wave line propagation time. As this line consists of only overhead line, each cable propagation time is zero.

This relay can calculate both two fault locator at two terminal and one fault locator at one terminal. The blue line is the time when travelling wave arrives at terminal Shinjecheon, the red line is the time when travelling wave arrived at terminal Donghae at the Fig.12. And the green line and blue line are the first and second time when travelling wave arrives at terminal Shinjecheon, and the red line is the time when travelling wave arrives at terminal Donghae from Fig.13 to Fig.15.

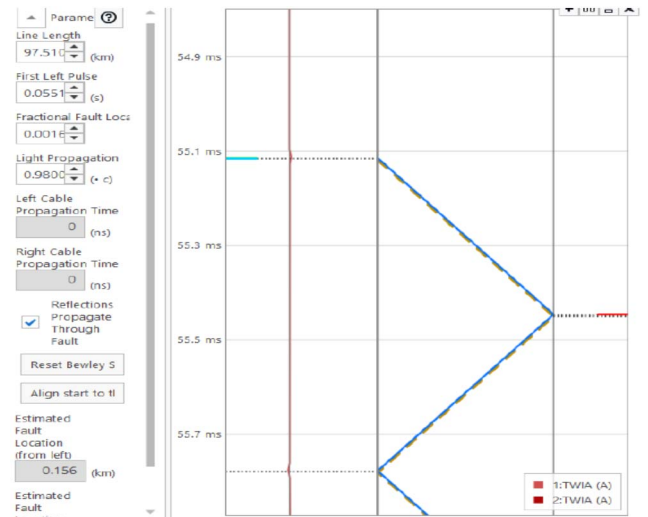

Fig. 12. Travelling wave characteristics at 0% location with T400

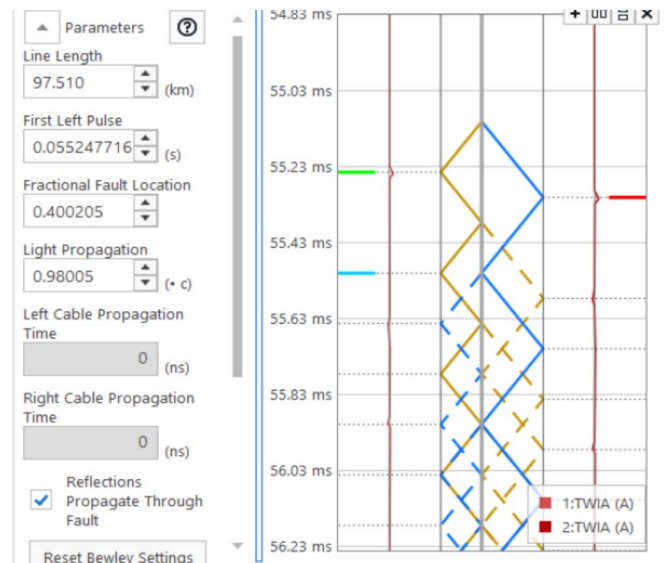

Fig. 13. Travelling wave characteristics at 40% location with T400

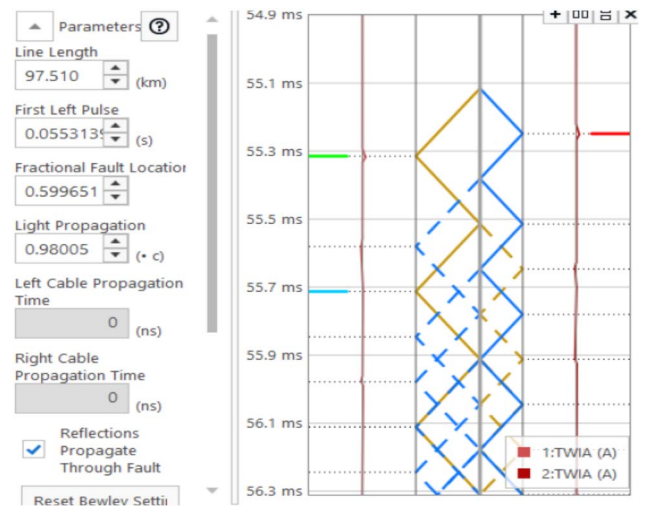

Fig. 14. Travelling wave characteristics at 60% location with T400



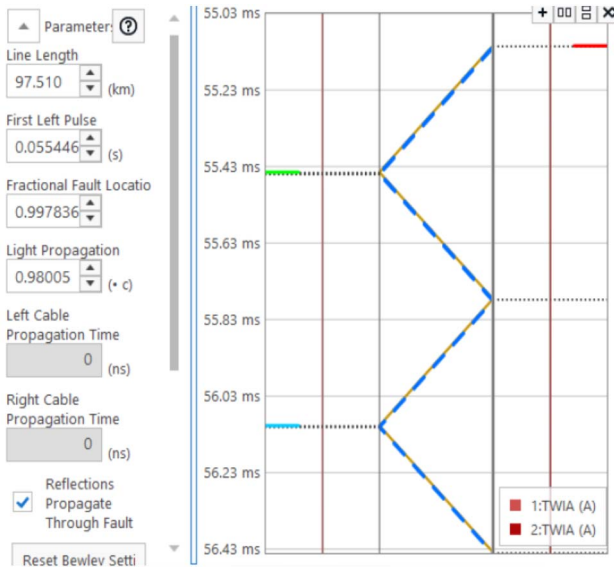

Fig. 15. Travelling wave characteristics at 100% location with T400

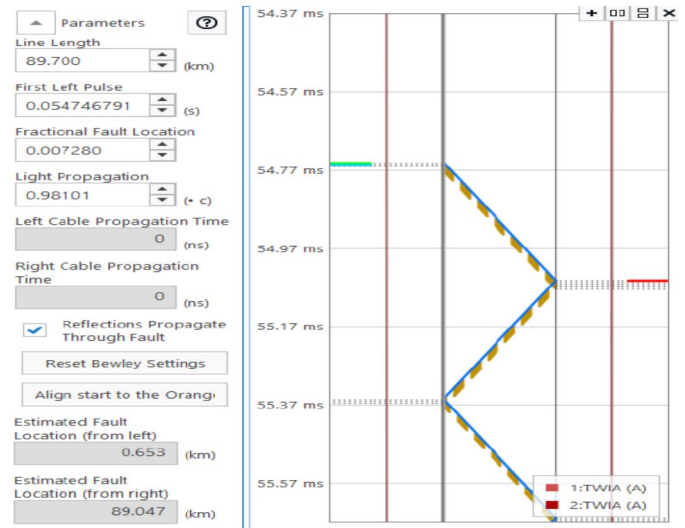

Fig. 16. Travelling wave characteristics at 0% location with T400

The error between T400 fault locator and calculated distance can be calculated from equation (5).

$$E(\%) = \frac{|actual\ location - calculated\ location|}{total\ cable\ length} \times 100\% \quad (5)$$

TABLE II. RESULT OF FAULT LOCATION OF SHINJEcheon-DONGHAE

Fault point	T400 distance[km]	Calculated distance[km]	Error[%]
0%	0.156	0	0.15
40%	39.024	39.004	0.02
60%	58.472	58.505	0.03
100%	97.299	97.510	0.21
Average error[%]			0.10

### B. Shinyoungju-Hanul

From Fig.16 to Fig.19 show the current travelling waves from terminals Shinyoungju and Hanul associated with Phase A fault. The fault distances from Shinyoungju substation are at 0%, 40%, 60%, 100% location. Each distance is calculated from equation (3), (4).

The line distance is 89.7km. First left pulse means the time when the travelling wave arrives at terminal Shinyoungju after fault. As this line also consists of only overhead line, each cable propagation time is zero.

The green line is the time when travelling wave arrived at terminal Shinyoungju, the red line is the time when travelling wave arrives at terminal Hanul at the Fig.16. And the green line and blue line are the first and second time when travelling wave arrives at terminal Shinyoungju, and the red line is the time when travelling wave arrives at terminal Hanul from Fig.16 to Fig.19.

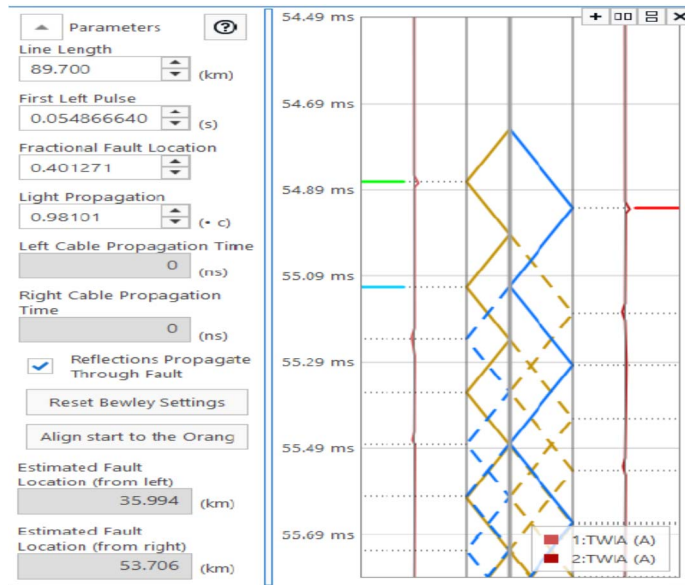

Fig. 17. Travelling wave characteristics at 40% location with T400

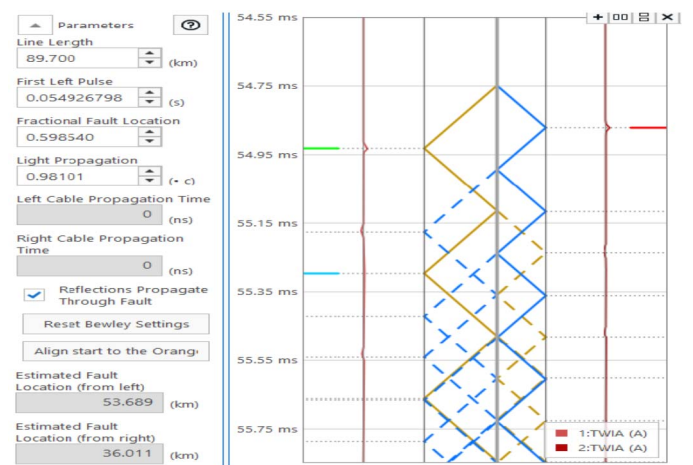

Fig. 18. Travelling wave characteristics at 60% location with T400

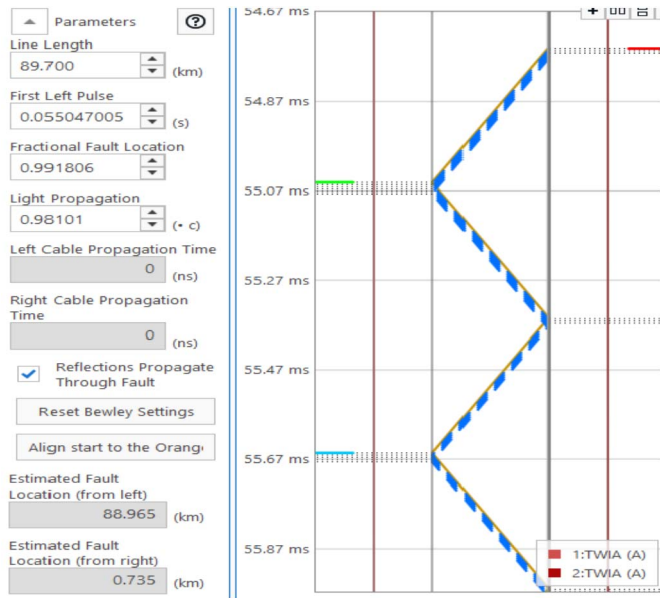

Fig. 19. Travelling wave characteristics at 100% location with T400

TABLE III. RESULT OF FAULT LOCATION OF SHINYONGJ-HANUL

Fault point	T400 distance[km]	Calculated distance[km]	Error[%]
0%	0.65	0	0.72
40%	35.99	35.88	0.12
60%	53.69	53.82	0.14
100%	88.97	87.70	0.30
Average error[%]			0.32

## VI. CONCLUSION

TCSC systems have been installed at two substations in Korea. These systems use capacitor to compensate active power when 765kV line fails. However, as line impedance changes, the conventional fault locator using impedance method has possibility not to detect exact fault locations in case of fault of TCSC line. And, it is not easy to establish line PT due to physical situation at Shinjcheon substation. Therefore, we need another fault locators using travelling wave method to detect fault locations.

We made contrade files at 0%, 40%, 60%, 100% locations with modified PSCAD/EMTDC based on a model which manufacture company supplied. And we studied how to calculate the distance from each substation to fault locations. After that, we tested with two real fault locators.

The test result showed that error of distance is almost within 0.1% at Shinjecheon-Donghae line and error of distance is almost within 0.32 % at Shinyougju-Hanul line. The result showed us that the fault locator using travelling wave is very exact. We could understand that travelling wave method is very useful at TCSC lines.

## REFERENCES

- [1] Anderson, M. Eden, P. Laplante, and W. D. Reeve, "Understanding FACTS", pp. 229-236, 2000.
- [2] S. Jamhoria and L. Srivastava, "Applications of thyristor controlled series compensator in power system: An overview," 2014 Int. Conf. Power Signals Control Comput. EPSCICON 2014, no. January, pp. 8-10, 2014.
- [3] Seyyed Mohammad and Mehdi Akhbari, "A new algorithm for fault location in series compensated transmission lines with TCSC", Electrical and Energy System journal, pp.1-2, 2013.
- [4] Papiya Ray and Debani prasad mishra, "Location of the fault in TCSC based transmission line using SVR", 2016 Int. Conf. on information Technology, 2016 IEEE, pp.1, 2016.
- [5] Ganiyu Adedayo and Segun, "An Overview of Impedance-Based Fault Location Techniques in Electrical Power Transmission Network", Int. Journal of Advanced Engineering Research and Applications, pp.126-129, 2016.
- [6] M. Vintins, "A Fundamental Concept for High Speed Relaying", IEEE Trans., PAS-100, No.1, 1607, 1981.
- [7] Thomas Hensler and Christopher pritchard, "Component and traveling wave Line Protection", Time-Doman Principles, 2018.
- [8] Nicholas Metzger and Benjamin Carstens, "Practical Experience With Ultra-High-Speed Line Protective Relays", 22<sup>nd</sup> Annual Georgia Tech Fault and Disturbance Analysis Conference, 2019.
- [9] Sthitaprajnyan Sharma and Mangapathiroa, "Field Experience with an Ultra-High-Speed Lone Relay and Traveling-wave fault locator", 45<sup>th</sup> Annual Western Protective Relay Conference, 2018.