



## MPC Operation with Improved Optimal Control Problem at Dalsfoss Power Plant.

---

Changhun Jeong, Beathe Furenes and Roshan Sharma

EasyChair preprints are intended for rapid dissemination of research results and are integrated with the rest of EasyChair.

October 9, 2021

# MPC Operation with Improved Optimal Control Problem at Dalsfoss Power Plant

Changhun Jeong<sup>1</sup> Beathe Furenes<sup>2</sup> Roshan Sharma<sup>1</sup>

<sup>1</sup>Natural Sciences and Maritime Sciences Department of Electrical engineering, Information Technology and Cybernetics, University of South-Eastern Norway, Porsgrunn, Norway

{Changhun.Jeong, Roshan.Sharma}@usn.no

<sup>2</sup>Skagerak Kraft AS, Norway

## Abstract

The operational conditions at the Dalsfoss power station are complicated due to many requirements such as environmental regulations and safety constraints. Model predictive control (MPC) has been in use at this power station to control the floodgates at the Dalsfoss dam. However, the current formulation of MPC at the power plant does not have routines to explicitly handle output constraints. In this paper, a new improved optimal control problem (OCP) is formulated for the operation of the flood gates at the Dalsfoss power station. This new OCP formulation is thought to be relatively easier for the operators to understand and it is more flexible to the violation of constraints. The aim of this paper is to extend the current MPC used at the power plant so that the output constraints are systematically included in the new improved MPC formulation. Two alternatives are presented and their robustness to an uncertain disturbance is analyzed through robustness analysis.

*Keywords: Model predictive control, optimal control problem, flood management, uncertainty, robustness analysis*

## 1 Introduction

Kragerø watercourse is one of many watercourse systems that Skagerak Kraft operates. The watercourse contains one dam and five hydropower stations which are located between lake Toke and the sea sequentially along the watercourse as shown in Figure 1. Its catchment area is over 1200 square kilometres and lies mainly in Telemark, Norway. The uppermost power plant is the Dalsfoss power plant which is located next to the dam (SkagerakKraft, 2021b). The system has intakes to three turbines and two flood gates (SkagerakKraft, 2021a).

Skagerak Kraft is fully responsible for the safety of the operations at the Dalsfoss power station. Therefore, requirements by the Norwegian Water Resource and Energy Administration (NVE) must be complied with to ensure safe and environmental-friendly operation. Some of these requirements are environmental-related and are imposed to prevent damages to the inhabitants and the ecosystem



**Figure 1.** Overview of the Kragerø watercourse (SkagerakKraft, 2021b).

around the water system. One of the most important constraints is to maintain the level of water at Merkebekk within a specific range. The range is not constant and changes over the months within a year (NVE, 2021). It is not easy to satisfy the requirement all the time during the operation due to two uncertainties in the system. One is the power production plan to meet the energy demand. The other is the water inflow to the lake/dam. Skagerak Kraft creates the power production plan and uses it to operate the plant. Water inflow to the lake is predicted by using a complex hydrological model and weather forecast information. As the result, the predicted water inflow is given as 50 possible future scenarios for the next 13 days.

MPC is known as an attractive multivariable constrained control approach with its ability to effectively deal with the complex dynamics of systems with multiple inputs and outputs and constraints. (Morari and H. Lee, 1999; Mayne, 2014). Therefore, a reference region tracking MPC based on a mathematical model of the system was suggested for the operation of the Dalsfoss power station (Lie, 2014). More research has been conducted since the first MPC was suggested in 2014. A better parameter fitting on the model was suggested due to a poor description of the model during a severe flood in September 2015



where  $C_d$  is discharge coefficient and  $g$  is acceleration of gravity.

The total water outflow from the Dalsfoss power station,  $\dot{V}_o$ , is calculated as:

$$\dot{V}_o = \dot{V}_t + \sum^j \dot{V}_{g,j} \quad (8)$$

The dynamic model of states,  $h_1$  and  $h_2$ , are expressed as:

$$\frac{dh_1}{dt} = \frac{1}{(1-\alpha)A(h_1)}((1-\beta)\dot{V}_i - \dot{V}_{12}) \quad (9)$$

$$\frac{dh_2}{dt} = \frac{1}{\alpha A(h_1)}(\beta\dot{V}_i + \dot{V}_{12} - \dot{V}_t - \dot{V}_g) \quad (10)$$

Parameters for the model are given in Table 1.

## 2.2 Operational constraints

Operational constraints on lake Toke are specified by NVE. They are designed to achieve (i) operational safety, (ii) securing ecological diversity, and (iii) avoiding property damage, e.g., by maintaining certain minimum and maximum levels at Merkebekk. The key constraints for a flood situation are:

1. The total water outflow from the Dalsfoss power station,  $V_o$ , should remain as steady as possible. This requirement is to keep people and animals safe from the sudden change of the water outflow and level at the downstream.
2. The minimum flow rate of the total water outflow should be bigger than  $4\text{m}^3/\text{s}$ . This restriction is not to disturb the ecosystem in the downstream, e.g to allow fishes to move freely, etc.
3. The water level at Merkebekk,  $x_M$ , must stay within a range:

$$x_M \in [x_{LRV}, x_{HRV}]$$

where  $x_{LRV}$  and  $x_{HRV}$  denote the low regulated value and the high regulated value for the water level respectively. The seasonal change on level constraints throughout a year is briefly shown in Figure 4. This level constraint exists for not disturbing fauna along the shoreline, but also to prevent damages or inconvenience such as flooding properties or putting boats on dry land, etc. This constraint can be violated to satisfy the second constraint by going lower than  $x_{LRV}$ . However, the level of water at Merkebekk should never exceed the maximal high regulated value denoted as  $x_{HRV}^{\max}$ .

4. When severe flooding occurs  $x_M$  can exceed  $x_{HRV}$ . However, after the culmination of flooding ends,  $x_M$  must reach  $x_{HRV}$  as soon as possible.

5. When the winter operation is terminated, the water level in the reservoir must reach  $x_{LRV}^{\text{summer}}$  quickly. However, the flow rate at the downstream,  $V_o$ , is limited to  $20\text{m}^3/\text{s}$  until the water level is at the target level.
6. Although there is the minimum required flow rate at the downstream,  $V_o \geq 4\text{m}^3/\text{s}$ , it is more beneficial economically to have the flow rate larger than  $10\text{m}^3/\text{s}$ , which enables the operation of the four sequentially located power plants along the watercourse.

The fourth and fifth constraints mentioned above requires the judgement of the professional on sites such as when flooding begins and when the winter operation is completed. Therefore, in this paper, the two constraints are not considered.

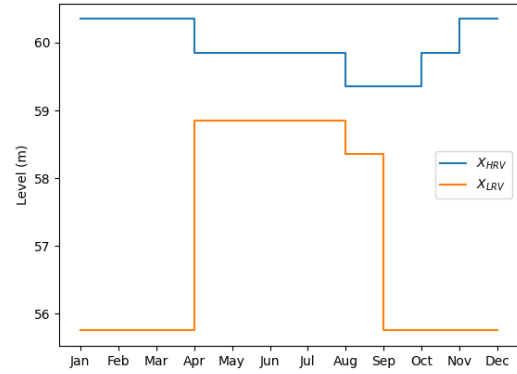


Figure 4. Water level constraint changes throughout year

## 3 Optimal Control Formulation

In this section, two alternative OCP formulations to improve the the current MPC used at Dalsfoss hydropower plant are presented. These two alternative MPC formulations can be regarded as extensions of the current MPC.

### 3.1 Reference region tracking OCP with output constraints

In the reference region tracking MPC currently being used at Dalsfoss, the water level at the dam is controlled to lie between the upper and the lower limits (see Figure 4) by formulating a complex objective function containing a reference region as,

$$\min \sum_{i=1}^N \omega_R R^2(x_{t+i}) + \omega_{\Delta u} \Delta u_{c,t+i-1}^2 + \omega_u u_{c,t+i-1}^2 \quad (11)$$

Here  $\omega$  is a weight matrix and  $N$  is length of the prediction horizon.  $u$  is control input and it has operational constraint such as  $u_{c,i} \in [0, h_{g,\max}]$ .  $h_{g,\max}$  means the maximal

**Table 1.** Parameters for Lake Toke model

Parameter	Value	Unit	Comment
$\alpha$	0.05	-	Fraction of surface area in compartment 2
$\beta$	0.02	-	Fraction of inflow to compartment 2
$K_{12}$	800	$\text{m}^{\frac{3}{2}}/\text{s}$	Inter compartment flow coefficient
$C_d$	0.7	-	Discharge coefficient, Dalsfoss gate
$w_1$	11.6	m	Width of Dalsfoss gate 1
$w_2$	11.0	m	Width of Dalsfoss gate 2
$x_{\text{LRV}}^{\text{min}}$	55.75	m	Minimal low regulated level value
$x_{\text{HRV}}^{\text{max}}$	60.35	m	Maximal high regulated level value
$g$	9.81	$\text{m}/\text{s}^2$	Acceleration of gravity

allowed opening height of the floodgate.  $\Delta u$  denotes the gate opening changes which is:

$$\Delta u_{c,t} = u_{c,t} - u_{c,t-1} \quad (12)$$

The level reference term in Equation 11,  $R^2(x_{t+i})$ , is expressed as:

$$R(x_{t+1}) = \min(x_{\text{M},t+1} - \gamma_{t+i}^{\text{l}}, 0) + \max(x_{\text{M},t+1} - \gamma_{t+i}^{\text{u}}, 0) \quad (13)$$

where  $\gamma_{t+i}^{\text{l}}$  and  $\gamma_{t+i}^{\text{u}}$  work as lower and upper boundaries of the reference region. They are calculated by:

$$\gamma_i^{\text{l}} = (1 - X_{\text{R}})x_{\text{LRV},i} + X_{\text{R}}x_{\text{HRV},i} \quad (14)$$

$$\gamma_i^{\text{u}} = f(x_{\text{HRV}}) - \delta_{\text{HRV}} \quad (15)$$

where  $X_{\text{R}}$  and  $\delta_{\text{HRV}}$  are the variable inputs that engineers can put their insight into. A typical value for  $X_{\text{R}}$  is 0.75. The purpose of  $\delta_{\text{HRV}}$  is to have a slight margin wrt. the maximal allowed level for  $x_{\text{M}}$ .  $f(x_{\text{HRV}})$  is decided based on whether excessive flooding occurs or not as follow:

$$f(x_{\text{HRV}}) = \begin{cases} x_{\text{HRV}}^{\text{max}}, & \text{for excessive flooding} \\ x_{\text{HRV}} & \text{otherwise} \end{cases}$$

The reference level term in Equation 11 becomes zero when the water level at Merkebekk stays in the reference range defined by Equations 14 and 15. The reference term is only activated when the water level is outside of the reference range. Therefore, the weight on the use of floodgates (i.e. control inputs) and the rate of change of control inputs are more emphasized when the water level remains in the specified reference range. In this formulation, the only constraints are the input constraints, and the constraints on the water level are really only handled as a complex cost function. It is a well-known fact that only using a cost function does not guarantee constraint satisfaction. In this paper, the addition of output constraints on the water level at Merkebekk is suggested as,

$$x_{\text{LRV}} \leq x_{\text{M}} \leq f(x_{\text{HRV}})$$

### 3.2 New OCP with constraint relaxation

When handling the flood gates, care should be taken that the water from the dam is not let out through flood gates unnecessarily. This would result in loss of water which otherwise could be used to produce electricity. In this sense, saving as much water as possible (i.e. having as high water level as possible) in the dam while still satisfying the concession requirements also becomes necessary. In this newly formulated OCP, the objective function is designed to maximize the water level at Merkebekk and is simpler compared to the objective function in the reference region tracking OCP, Equation 11 as:

$$\min \sum_{i=1}^N \omega_{\text{R}} R_{\text{new}}^2(x_{t+i}) + \omega_{\Delta u} \Delta u_{c,t+i-1}^2 + \omega_{\text{u}} u_{c,t+i-1}^2 + p^2 \omega_{\text{p}} \quad (16)$$

The new reference term in Equation 16 is expressed as:

$$R_{\text{new}}(x_{t+1}) = x_{\text{M},t+1} - f(x_{\text{HRV}}) \quad (17)$$

Equation 17 is simpler than Equation 13. It is not only more effective to preserve the water as much as possible in the reservoir, but also easier for operators and engineers to understand.

The last term,  $p^2 \omega_{\text{p}}$  which is the penalty for violation of level constraints, is newly added. The variable  $p$  is the slack variable which is used to modify the level constraints as:

$$x_{\text{LRV}} + p \leq x_{\text{M}} \leq f(x_{\text{HRV}})$$

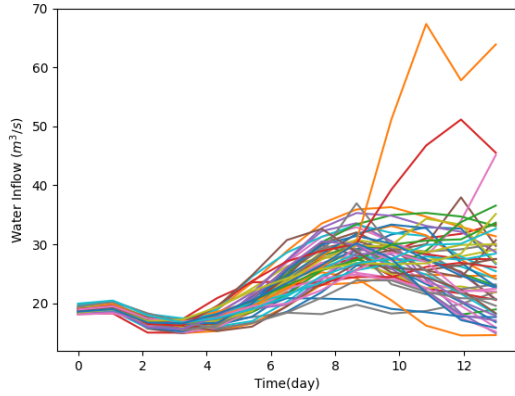
The value of the slack variable is automatically decided by the optimizer since it is added to the list of the decision variable (Sharma, 2020). This term can offer more flexibility on optimization when the constraints are violated, for example when  $x_{\text{M}}$  goes lower than  $x_{\text{LRV}}$  to satisfy the minimum flow rate requirement on the total outflow,  $V_{\text{o}} = 4\text{m}^3/\text{s}$ , the optimization would not fail (due to infeasibility) and cause the malfunction of the controllers in the system.

## 4 Simulation of Nominal MPC

This section presents the simulation results of nominal MPC using the two alternative OCP formulations as described in Section 3. For the simulation, the two disturbances, the power production plan and the water inflow to the lake Toke must be described.

For the simplicity of the simulation, the power production plan is assumed to generate maximum power. This can be achieved by setting a fixed value on  $V_t$  as  $36\text{m}^3/\text{s}$ . This is the maximum flow rate that can pass through the turbine at Dalsfoss hydropower station.

The actual data of water inflow prediction stored by Skagerak Kraft is applied for the simulation. The water inflow prediction is given each day as 50 possible future scenarios for the next 13 days. An example of the water inflow prediction is shown in Figure 5. It is the historical inflow prediction data recorded on 15th April 2020. The deviation of the inflow prediction tends to be bigger as time marches further into the future. The prediction data can be expressed in matrix form as Equation 18.



**Figure 5.** 50 ensembles of the water inflow prediction to lake Toke on April 15 2020

$$\dot{V}_{i,t} = \begin{pmatrix} \dot{V}_{i,t}^{(1)} & \dot{V}_{i,t}^{(2)} & \cdots & \dot{V}_{i,t}^{(50)} \\ \dot{V}_{i,t+1}^{(1)} & \dot{V}_{i,t+1}^{(2)} & \cdots & \dot{V}_{i,t+1}^{(50)} \\ \vdots & \vdots & \ddots & \vdots \\ \dot{V}_{i,t+12}^{(1)} & \dot{V}_{i,t+12}^{(2)} & \cdots & \dot{V}_{i,t+12}^{(50)} \end{pmatrix} \quad (18)$$

The rows in Equation 18 shows the time evolution of the water inflow prediction and the column represents the different 50 possible scenarios of water inflows. The prediction of the inflow to the lake is updated every 24 hours. For simulation of nominal MPC, the average value of the water inflow prediction is used. It is calculated as:

**Table 2.** Parameters for the simulations

Parameter	Value	Unit
$X_R$	0.75	-
$\delta_{HRV}$	0.05	m
$\omega_R$	10	-
$\omega_{\Delta u}$	1	-
$\omega_u$	1	-
$\omega_p$	100	-
$h_{g,\max}$	5.6	m

$$\dot{V}_{\text{avg},t} = \begin{pmatrix} \text{Mean}(\dot{V}_{i,t}^{(1)}) & \dot{V}_{i,t}^{(2)} & \cdots & \dot{V}_{i,t}^{(50)} \\ \text{Mean}(\dot{V}_{i,t+1}^{(1)}) & \dot{V}_{i,t+1}^{(2)} & \cdots & \dot{V}_{i,t+1}^{(50)} \\ \vdots & \vdots & \ddots & \vdots \\ \text{Mean}(\dot{V}_{i,t+12}^{(1)}) & \dot{V}_{i,t+12}^{(2)} & \cdots & \dot{V}_{i,t+12}^{(50)} \end{pmatrix} \quad (19)$$

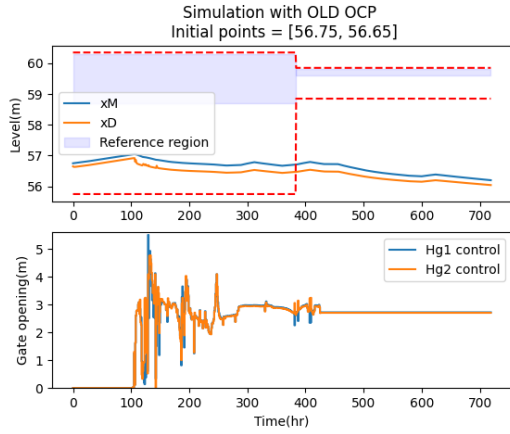
The average is calculated on each time step with a new set of the water inflow prediction. The water inflow prediction based on the historical data is multiplied by a flood coefficient to simulate the flooding situations. The flood coefficient is set as 3 for the nominal MPC.

The period of simulation is set from April 15 to May 15 and includes a drastic change of the level constraints at Merkebekk. The simulation is performed with two different initial points for the water level to demonstrate two different situations. One initial point for the water level is located lower than the reference region and the other initial point is located in the reference region. Parameters for the OCPs are presented in Table 2. For the optimization, IPOPT in CasADi is used in Python (Andersson et al., 2019).

### 4.1 Simulation result: Initial water level below the reference region

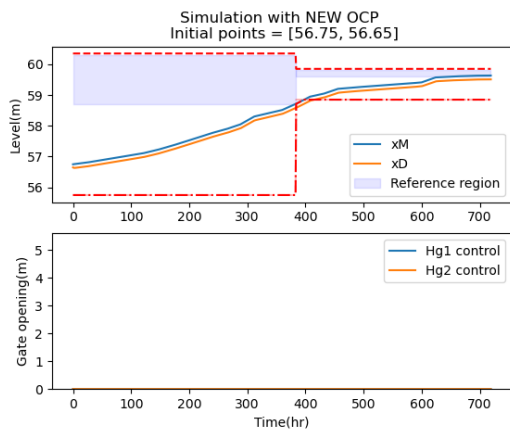
Figure 6 shows the result of the simulation of nominal MPC at Dalsfoss power station using the reference region tracking MPC with output constraints when the initial water level at Merkebekk is below the reference region. The upper figure shows the level control and the lower figure shows the control actions during the simulation. The floodgate is supposed to remain closed to make the water level reach the reference region. However, floodgates are drastically opened several times and remain opened. It causes the water level to drop since the water is being thrown out from the reservoir. This abnormal action is due to the optimization problem becoming infeasible and the time-varying level constraints not being satisfied at such low water level. The optimizer then fails to find an optimal solution and produces incorrect and abnormal results.

Figure 7 shows the result of the simulation of nominal MPC using the newly formulated OCP with constraint relaxation as described in Section 3.2. The upper plot in Figure 7 represents the level changes and the lower plot shows the floodgate openings during the simulation. Thanks to



**Figure 6.** Simulation result of MPC at Dalsfoss station using the reference region tracking OCP with output constraints for initial water level lower than reference region. (upper plot - level control, lower plot - floodgate opening)

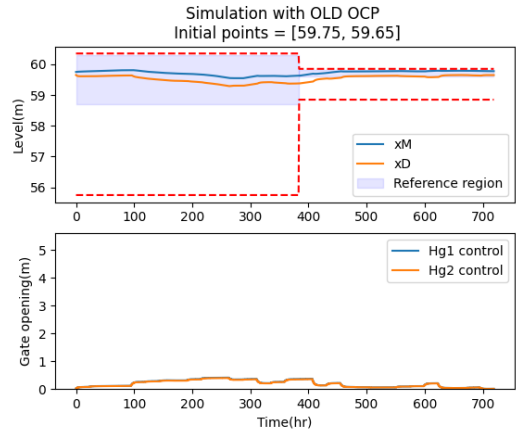
the penalty term,  $p^2\omega_p$ , in Equation 16, in the newly formulated OCP, output constraint (water level) relaxation is possible due to the use of slack variables. This does not cause any failures of optimization problem during the simulation. Therefore, as it is supposed to be, the floodgate stays closed. Despite the violation of the level constraint at around 380 hours, the water level is maximized and the level constraints are satisfied later at around 400 hours. The reason that the level constraint (lower constraint) is not fulfilled at ca. 380 hours is due to the control signals being saturated. The flood gates are completely closed and the inflow to the lake is not sufficiently large. Under this circumstance, this is the best the new OCP can perform without failing due to constraint relaxation.



**Figure 7.** Simulation result of MPC at Dalsfoss station using the new OCP with constraint relaxation for initial water level lower than reference region. (upper plot - level control, lower plot - floodgate opening)

## 4.2 Simulation result: Initial water level in the reference region

Figure 8 shows the simulation result of nominal MPC using the reference region tracking MPC with output constraints. The initial point for the water level at Merkebekk is located inside of the reference region. The upper plot in Figure 8 shows the level change and the lower plot shows the gate openings during the simulation. The water level remains nearly constant but the water level is not maximized. The gate stays constantly opened and thus results in unnecessary loss of water through the flood gates.



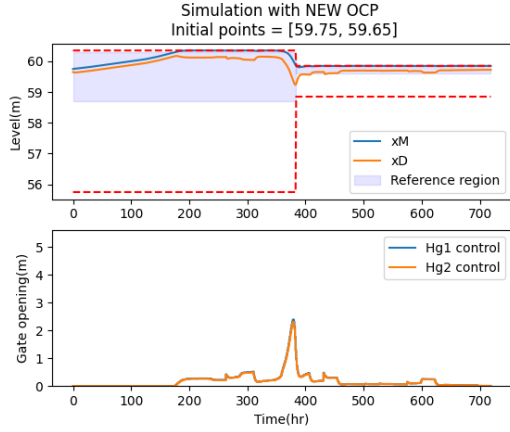
**Figure 8.** Simulation result of MPC at Dalsfoss station using the reference region tracking MPC with output constraints for initial water level in reference region. (upper plot - level control, lower plot - floodgate opening)

The simulation result of nominal MPC using the new OCP with constraint relaxation with an initial water level lying inside of the reference region is displayed in Figure 9. The upper plot shows the level change and the lower plot shows the gate openings during the simulation. The water level is maximized as intended to save as much useful water as possible in the dam. Achieving a higher level at the dam while still satisfying the concession requirement means more water is preserved in the reservoir, and this extra water can then be sent through the turbine later on to produce useful electric power (increased profit). This shows that the new OCP with constraint relaxation results in an improved operation of the hydropower plant.

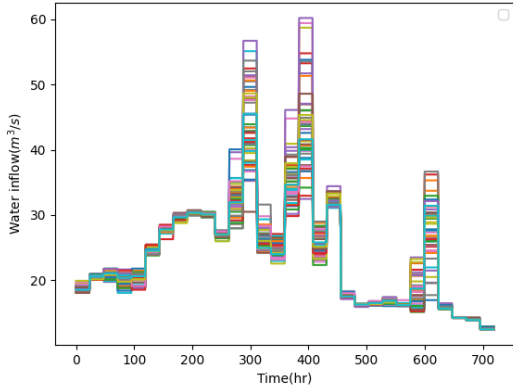
## 5 Robustness Analysis

The realization of all possible water inflow, which means the first data of water inflow prediction on every update of the prediction every day, is presented in Figure 10.

With robustness analysis, the goal is to use the nominal MPC to all the individual 50 ensembles of the water inflow predictions. In other words, robustness analysis enables us to study the effect of applying a nominal/deterministic MPC to an uncertain system. Here uncertainty lies in the fact that any one of the 50 possible inflow forecasts can occur in the future in the real plant. The robustness analy-



**Figure 9.** Simulation result of MPC at Dalsfoss station using the new OCP with constraint relaxation for initial water level in reference region. (upper plot - level control, lower plot - floodgate opening)

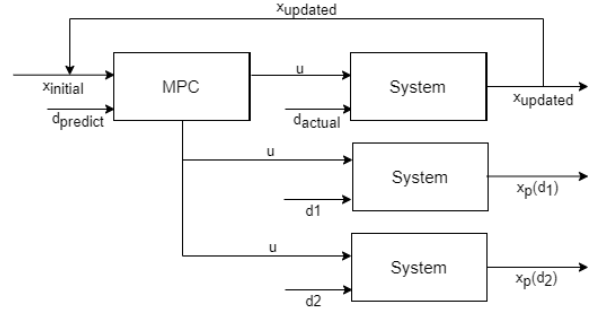


**Figure 10.** Plot of water inflow prediction

sis shows the possibility of constraint violation due to the influence of uncertainty. Since there are significant deviations in the realization of water inflow in each scenario, this section presents the result of the robustness analysis of nominal MPC using both OCPs as described in Section 3 at the Dalsfoss power station.

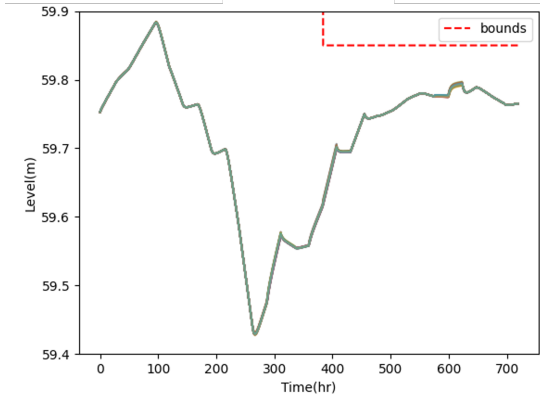
For robustness analysis, the nominal scenario must be chosen to get a sequence of the applied control input throughout the simulation time. Then, the sequence of the applied control input is used to evolve the states with different inflow forecast scenarios of the uncertainty by the system model as shown in Figure 11. The first scenario of water inflow prediction,  $(\hat{V}_{i,t}^{(1)}, \dots, \hat{V}_{i,t+12}^{(1)})$  in Equation 18, is chosen as the nominal prediction set and the other scenarios are considered as the possible future occurrences.

The flooding coefficient is set as 3 for the analysis. The initial water levels are located inside of the reference region so that the OCP for the reference region tracking MPC with output constraints does not fail to converge due to the violation of the time-varying level constraints (i.e., due to infeasibility).



**Figure 11.** Scheme of robustness analysis

Figure 12 displays the result of the robustness analysis of nominal MPC with the reference region tracking OCP with output constraints. The violation of the level constraint does not occur. However, the water level is remained in the reference region instead of achieving the optimal states, i.e., maximizing the water level.



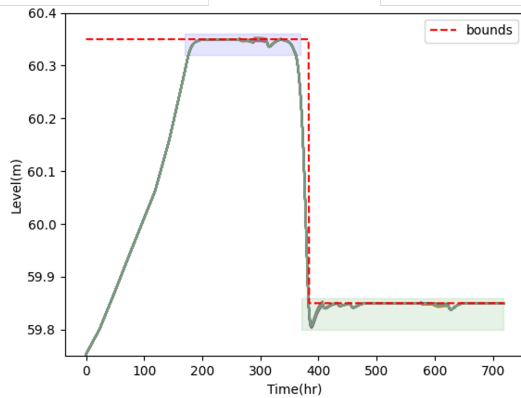
**Figure 12.** Robustness analysis on level control at Dalsfoss power station using the reference region tracking MPC with output constraints

The robustness analysis result with the new OCP with constraint relaxation is shown in Figure 13. The areas marked by blue and green colours in Figure 13 are displayed in Figure 14 and Figure 15 respectively. The potential violation of the level constraint is detected by 1384 times throughout the simulation period. when the nominal MPC with new OCP is applied to the uncertain system, the level constraints are not always satisfied for all the possible water inflows to the lake that can happen in the future. Some realizations can result in the violation of constraints. This reflects reality since in the real plant, water inflow to the lake can be dictated by one (or some other) of the possible forecast realizations.

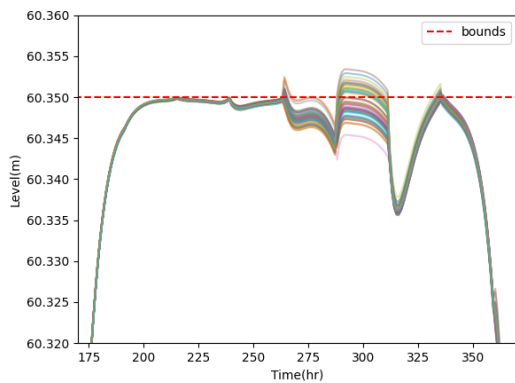
## 6 Conclusion

The new OCP with constraint relaxation shows some improvements over the OCP for the reference region tracking MPC with output constraints. As presented in section 4, it not only saves more water in the reservoir compared to the reference region tracking MPC with output constraints but

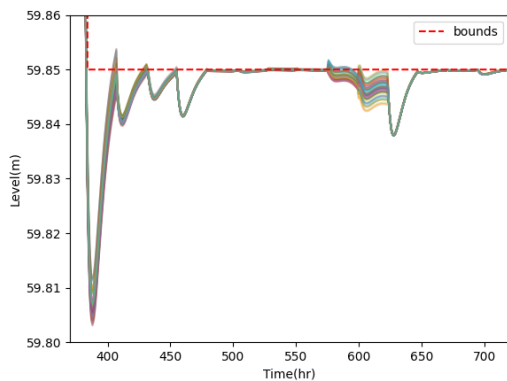




**Figure 13.** Robustness analysis on level control at Dalsfoss power station using the new OCP with constraint relaxation



**Figure 14.** Enlarged robustness analysis on level control at Dalsfoss power station using the new OCP with constraint relaxation : time = [170,370]



**Figure 15.** Enlarged robustness analysis on level control at Dalsfoss power station using the new OCP with constraint relaxation : time = [370,720]

also, did not cause any failure on optimization due to infeasibilities. Also, since the new OCP with constraint relaxation is simpler, it should be easier for the operators and engineers on the site to understand. More study should be performed with the new OCP with constraint relaxation

by using more realistic operational scenarios including the use of power production plan in the future.

In robustness analysis, a flood situation is assumed by setting the flood coefficient as 3. The new OCP with constraint relaxation shows the vulnerability compared to the reference region tracking MPC in terms of the robustness of MPC. While the reference region tracking MPC has no potential violations on the level constraint, the MPC with new OCP displays 1384 times of the potential violation. However, this kind of possible constraint violation can be mitigated by employing a stochastic MPC or putting the safety margin. For the use of the stochastic MPC, the new OCP with constraint relaxation in this paper may be more beneficial to use due to its flexibility on output constrained optimization and its behaviour to save more water at the dam.

## References

Joel A E Andersson, Joris Gillis, Greg Horn, James B Rawlings, and Moritz Diehl. CasADi – A software framework for nonlinear optimization and optimal control. *Mathematical Programming Computation*, 11(1):1–36, 2019. doi:10.1007/s12532-018-0139-4.

Kristian D. Kvam, Beathe Furenes, Åsmund Hasaa, Alexander Zhang Gjerseth, Nils-Olav Skeie, and Bernt Lie. Flood control of lake toke: Model development and model fitting. 2017. ISSN 1650-3686. URL <http://hdl.handle.net/11250/2466966>.

Bernt Lie. Final report: Kontrakt nr inan-140122 optimal control of dalsfos flood gates- control algorithm. 2014.

David Q Mayne. Model predictive control: Recent developments and future promise. *Automatica (Oxford)*, 50(12):2967–2986, 2014. ISSN 0005-1098.

Itsaso Menchacatorre, Roshan Sharma, Beathe Furenes, and Bernt Lie. Flood management of lake toke: Mpc operation under uncertainty. 2019. ISSN 1650-3686.

Manfred Morari and Jay H. Lee. Model predictive control: past, present and future. *Computers chemical engineering*, 23(4):667–682, 1999. ISSN 0098-1354.

NVE. Supervision of dams, (accessed: 24.05.2021). <https://www.nve.no/supervision-of-dams/?ref=mainmenu>, 2021.

Roshan Sharma. Lectures note for course iia 4117 : Model predictive control in university of south-eastern norway. 2020.

SkagerakKraft. Dalsfos, (accessed: 24.05.2021). <https://www.skagerakkraft.no/dalsfos/category1277.html>, 2021a.

SkagerakKraft. Kragerø watercourse system, (accessed: 24.05.2021). <https://www.skagerakkraft.no/kragero-watercourse/category2391.html>, 2021b.