



## Investigating Efficient Probabilistic Modeling Technique for Frequency Stability Analysis of Future Power Systems

---

Ali Hakami, Mohammed Alzubaidi, Kazi Hasan and  
Manoj Datta

EasyChair preprints are intended for rapid  
dissemination of research results and are  
integrated with the rest of EasyChair.

January 9, 2024

# Investigating Efficient Probabilistic Modeling Technique for Frequency Stability Analysis of Future Power Systems

Ali M. Hakami  
School of Engineering  
RMIT University

Melbourne, Australia  
S3666426@student.rmit.edu.au

Mohammed Alzubaidi  
School of Engineering  
RMIT University

Melbourne, Australia  
s3583733@student.rmit.edu.au

Kazi N. Hasan  
School of Engineering  
RMIT University

Melbourne, Australia  
Kazi.hasan@rmit.edu.au

Manoj Datta  
School of Engineering  
RMIT University

Melbourne, Australia  
Manoj.datta@rmit.edu.au

**Abstract**— This paper compares two uncertainty modelling (UM) techniques to determine the accurate and efficient technique for probabilistic frequency stability assessment in large-scale power systems. The techniques are Monte Carlo (MC) and Quasi-Monte Carlo (QMC), which have been investigated in the context of their accuracy and efficiency. The performance of the UM techniques is evaluated using metrics such as the coefficient of determination ( $R^2$ ) and root mean square error (RMSE). By generating an extensive set of wind-speed random samples (8760 samples/simulations), both methods demonstrate remarkable accuracy, exceeding 99% when employing 1000 simulations. However, regarding efficiency, the QMC technique is more efficient than the MC technique, achieving an accuracy of over 96.5% with a considerably smaller number of generated samples and a shorter time (300 samples and in 3 minutes). In contrast, the MC technique achieves the same accuracy level (96.5%) by generating 1000 samples and requiring nearly 12 minutes for completion.

**Keywords**— Frequency stability analysis, Monte Carlo simulation, probabilistic modelling, quasi-Monte Carlo, renewable energy resources, uncertainty modelling technique.

## I. INTRODUCTION

Frequency stability analysis is crucial for contemporary power systems operating with a large share of inverter-interfaced renewable generation resources (RESs) within deregulated electricity markets. Hence, the increased integration of intermittent RESs, such as solar and wind power, introduces variability and uncertainty in power generation coupled with system load variations [1]. Maintaining frequency stability under uncertain conditions ensures that the power system can effectively balance the generation and load demand, even in the presence of these uncertainties in power systems [1-3]. The combination of intermittent RESs and variable system loads can elevate the risk of frequency instability [4]. However, the conventional deterministic stability analysis typically overlooks the variability inherent in RESs and system loads, focusing instead on predicting system behaviour based on worst-case scenarios [5]. Consequently, incorporating probabilistic frequency stability analysis encompassing a broad spectrum of system parameter variability becomes essential in power system planning and operation [6]. Therefore, using uncertainty modelling (UM) techniques enables a more precise representation of the system [7].

The UM techniques are valuable tools for dealing with the inherent uncertainties in complex systems. These techniques enable more informed decision-making and improve system behaviour prediction under uncertain conditions [8, 9]. The uncertainty modelling technique's primary purpose is to improve a system's operating uncertainties by showcasing its behaviour across a diverse set of potential scenarios. These techniques assist in identifying potential vulnerabilities, evaluating the effectiveness of risk mitigation strategies, and enhancing the overall decision-making process [10]. Various UM techniques, including MC and QMC, have been implemented to analyse the frequency stability with a probabilistic perspective. A diverse

array of UM techniques exists for assessing system uncertainties, necessitating thorough analysis and careful selection to ensure their appropriateness in probabilistic frequency stability analysis [3, 11].

The MC technique is a widely employed in the literature. This computational method uses random sampling to estimate the behaviour of complex systems or processes under uncertainty [12, 13]. It involves generating random samples, performing simulations or evaluations for each sample, and analysing the results statistically. This method is widely used in various fields to provide insights into system performance, support decision-making, and quantify risk [3, 11]. However, The MC technique is unsuitable for large systems due to its high computational requirements and the exponential increase in the number of simulations needed for accurate results, so this technique is not considered efficient [3, 14].

Different UM techniques have been employed individually to address the limitations of MC simulation. For instance, QMC has been utilised in frequency stability analysis to model uncertainties related to wind power variation and electric vehicle charging [15]. The maximum entropy method is employed in another study to characterise uncertainties in wind power and load variations within large-scale power systems [16]. In cases where renewable generation is absent, UM techniques represent uncertainties in power oscillation damping [17] and load variations [18]. Nevertheless, more comparative evaluations regarding the accuracy and efficiency of UM techniques must be conducted. Therefore, it is crucial to determine efficient UM techniques that can accurately evaluate the effect of network uncertainties on probabilistic frequency stability analysis.

This paper comprehensively investigates various UM techniques, including MC and QMC, to determine a more efficient and accurate probabilistic frequency stability analysis method in large-scale power systems. The study specifically focuses on incorporating the intermittent nature of uncertainties in system loads and wind generation as input variables in UM techniques. The accuracy and efficiency of two commonly used UM techniques, MC and QMC, are compared and evaluated. The analysis is conducted on the IEEE-39 bus network with three integrated wind farms to determine the UM technique that achieves optimal efficiency and accuracy. The accuracy of the UM techniques is assessed using metrics including  $R^2$  and RMSE.

The primary contributions of this research paper can be summarised into three key aspects:

- Implementing MC and QMC techniques with diverse computational regulations to produce precise uncertainties of wind speed in the sample dataset.
- Evaluating the efficiency (number of simulations) and accuracy ( $R^2$ , RMSE) of employed UM techniques for modelling wind power sample dataset uncertainties.
- Identifying an efficient and accurate UM technique for assessing probabilistic frequency stability in large-scale power systems.

The remaining sections of this paper are organised as follows: Section II presents the theoretical background of UM techniques in the context of frequency stability. Section III describes the research methodology and details the system under study. The simulation results and subsequent discussions are presented in Section IV. Finally, Section V highlights the critical observation and conclusion.

## II. THEORETICAL BACKGROUND OF UM TECHNIQUES FOR FREQUENCY STABILITY ANALYSIS

### A. Frequency Stability

Frequency stability refers to the capability of a power system to keep the system frequency within an acceptable range, specifically the standard operating frequency limit, following the occurrence of a contingency event [19, 20]. Any power system must ensure reliable and secure operation by maintaining the statutory voltage and frequency limits. Imbalances or instability in frequency can result in frequency swings, generator and load tripping, and other system failures. Frequency instability is often caused by insufficient system support, poor coordination of protection and control devices or inadequate generation supply [20]. Output indices are used to assess frequency stability, including the frequency nadir (minimum frequency level) [21], frequency (ROCOF) [21], frequency excursion (deviation from nominal frequency) [4, 22], and frequency response inadequacy (FRI) [22]. These indices provide valuable information about system behaviour and help operators evaluate and maintain stable frequency levels, ensuring reliable power system operation [19, 20].

### B. The Monte Carlo (MC) Simulation

The MC technique is widely recognised as the standard UM technique and is commonly used in various fields. By generating a large number (in the range of a few thousand) of random samples, the MC simulation can capture a wide range of possible outcomes, reducing the sampling error and improving the accuracy of the analysis, as shown in Fig. 1. It is based on generating random samples to approximate the outcomes of the system or process under investigation. This method involves generating random samples, performing simulations or evaluations for each sample, and analysing the results statistically [3, 7].

The MC stopping criteria formula is utilised in Monte Carlo simulations to determine the optimal number of samples needed for accurate results, as provided in (1) [3].

$$\varepsilon = \left[ \left\{ \Phi^{-1}(1 - (\delta/2)) \cdot \sqrt{\alpha^2(x)/N} \right\} c / \bar{x} \right] \quad (1)$$

In (1),  $\varepsilon$  represents the sampling error. The  $\Phi^{-1}$  is the inverted Gaussian standard probability distribution with a zero mean and one standard deviation.  $\bar{x}$  is the mean,  $\alpha^2(x)$  describes the variance of the samples, and  $\delta$  represents the confidence level.

### C. The Quasi Monte Carlo (QMC) Technique

Although similar to the standard MC approach, the QMC technique utilises a different technique to produce the sample sets. Unlike the MC technique, which adjusts sampling to cover the intended input domain, QMC employs pseudorandom sequences to create equidistant samples that accurately represent input distributions, as presented in Fig.1. When using QMC, system inputs are defined based on statistical properties, such as expectations, standard deviations, correlation matrix, higher moments, and the desired low-discrepancy sequences length (n). Deterministic simulation performance times are necessary for numerical calculations [23, 24].

The QMC technique, specifically the use of low-discrepancy sequences, is widely preferred for generating accurate and efficient samples due to its simplicity in implementation [25]. The Sobol sequence is generated using a specific algorithm that involves selecting a primitive polynomial of a certain degree ( $s_j$ ) in the field of binary integers ( $Z_2$ ), is selected. This polynomial is of the form specified in Equation (2) [26]. Where the coefficients  $a_{1,j}, \dots, a_{s_j-1,j}$  are either 0 or 1. These coefficients will be used to determine a sequence  $\{m_{1,j}, m_{2,j}, \dots\}$  of positive integers by the recurrence relation in Equation (3) [26]. For  $k \geq s_j + 1$ , where  $\oplus$  is the bit-by-bit exclusive-OR operator. The initial values  $m_{1,j}, m_{2,j}, \dots, m_{s_j,j}$  can be selected freely presented that each  $m_{k,j}$ ,  $1 \leq k \leq s_j$ , is odd and less than  $2k$ . The direction numbers  $\{v_{1,j}, v_{2,j}, \dots\}$  are determined by Equation (4) [26]. Then  $X_{i,j}$ , the  $j$ th components of the  $i$ th points in the Sobol samples, is calculated by Equation (5) [26].

$$x^{s_j} + a_{1,j}x^{s_j-1} + \dots + a_{s_j-1,j}x + 1 \quad (2)$$

$$m_{k,j} = 2a_{1,j}m_{k-1,j} \oplus 2^2a_{2,j}m_{k-2,j} \oplus \dots \oplus 2^{s_j-1}a_{s_j-1,j}m_{k-s_j+1,j} \oplus 2^{s_j}m_{k-s_j,j} \oplus m_{k-s_j,j}, \quad (3)$$

$$v_{k,j} := \frac{m_{k,j}}{2^k} \quad (4)$$

$$X_{i,j} = b_1v_{1,j} \oplus b_2v_{2,j} \oplus \dots, \quad (5)$$

### D. Evaluation Criteria

Various metrics for assessing the goodness of fit can be utilized to evaluate the accuracy of the chosen probability distribution. This study employs the  $R^2$  and RMSE criteria to assess the appropriateness of probability distributions for fitting

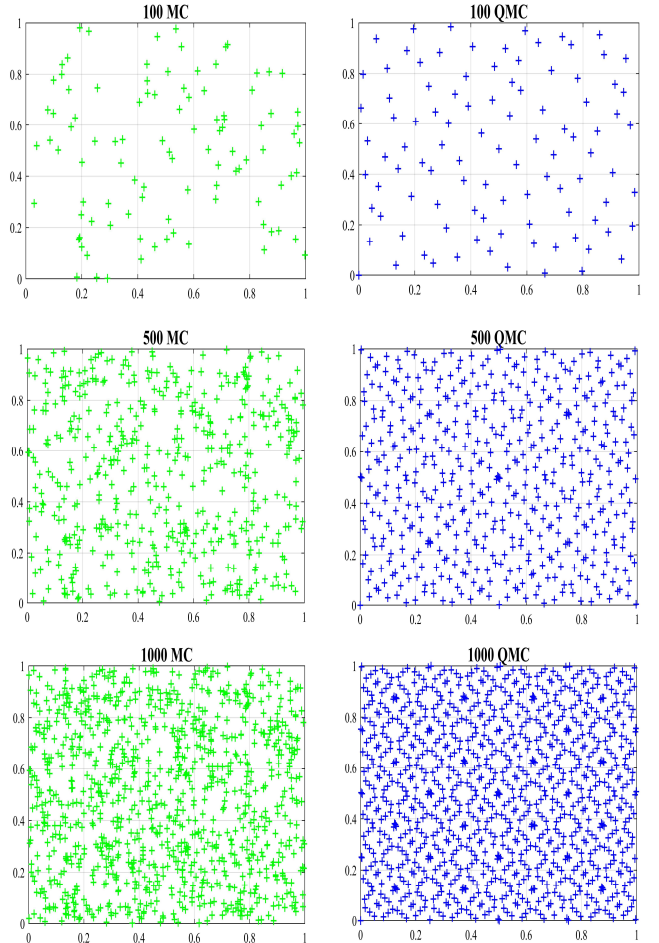

Fig. 1. Random samples (100, 500, and 1000) of MC technique and QMC technique respectively.

wind speed data [27]. The  $R^2$  and RMSE values are calculated using equations (6) and (7), respectively.

$$R^2 = 1 - \frac{\sum_{i=1}^n (x_i - y_i)^2}{\sum_{i=1}^n (x_i - z_i)^2} \quad (6)$$

$$RMSE = \sqrt{\frac{\sum_{i=1}^n (x_i - y_i)^2}{n}} \quad (7)$$

Where,  $i$  represents the index value ( $i = 1, 2, 3, \dots, n$ ),  $n$  is the length of the wind speed data,  $x_i$  is the original probability,  $y_i$  represents the predicted probability calculated from different PDFs, and  $z_i$  is the mean of the original dataset. It can be calculated as in (8) [27].

$$z_i = \frac{1}{n} \sum_{i=1}^n x_i \quad (8)$$

### III. RESEARCH METHODOLOGY AND SYSTEM DESCRIPTION

#### A. Research Methodology

The research methodology illustrated in Fig. 2 contains two separate sections. The first section involves the generation of wind speed random samples using the two UM techniques. In order to achieve this research's primary purpose, the MC technique generates a reference dataset comprising 8760 samples, accurately representing the actual wind speed data. Different UM techniques, including MC and QMC, are utilised to generate random samples of different sizes. These samples are then compared to the reference dataset to determine the more accurate and efficient UM technique for probabilistic frequency stability analysis. The comparison is based on  $R^2$ , RMSE values of the probabilistic frequency Nadir, leading to the identification of the optimal UM technique.

#### B. System Description

This study uses a modified version of the IEEE-39 bus network to conduct probabilistic frequency stability simulations. The network includes three wind farms; their corresponding data can be found in [28]. Fig. 3 provides a representation of this network. The integration of renewable energy sources (RES) is simulated by connecting three wind farms to system busbars 30, 34, and 37. These wind farms substitute three synchronous generators in the network, comprising around 20% (1240 MW) of the total generation capacity (6204 MW). DIgSILENT PowerFactory and MATLAB, two software platforms, are employed to analyse probabilistic frequency stability analysis.

#### C. Wind Generation

In this study, wind speed data collected from Northolt, UK [29] is utilised, spanning hourly measurements over one year, and is obtained to model wind farms connected to busbars 30, 34, and 37. The wind speed datasets are represented using the Weibull distribution, a commonly utilised probability distribution for describing wind speed fluctuations in previous studies [2, 30].

### IV. SIMULATION RESULTS AND DISCUSSION

#### A. Samples Generation using Different UM Techniques

The accuracy of the MC technique improves with increasing the number of simulations. Thus, the Monte Carlo technique generates the reference dataset of 8760 samples. Consequently, a reference dataset of 8760 samples is generated using the MC technique, providing a precise benchmark for comparison with wind speed datasets of different sizes of the two UM techniques (MC and QMC). The objective is to identify the more efficient

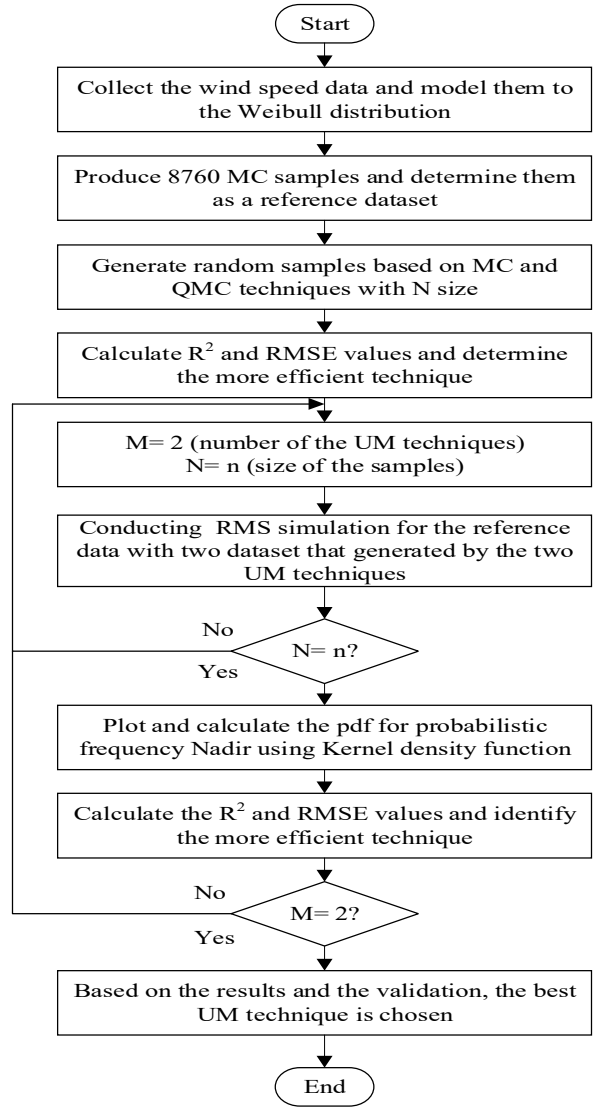

Fig. 2. The flowchart of this paper explaining the methodology.

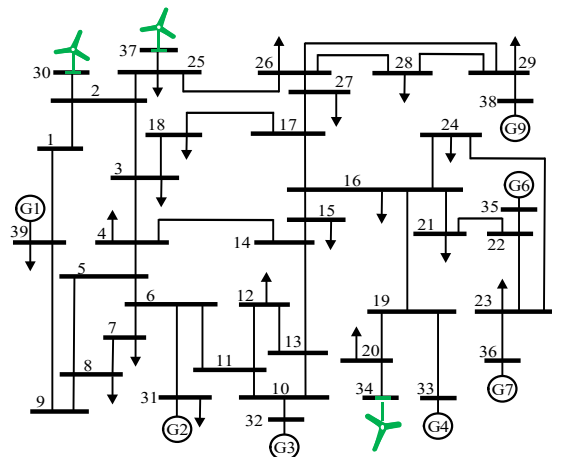

Fig. 3. The modified IEEE-39 bus network.

and accurate UM technique between MC and QMC for further probabilistic analysis.

Moreover, Fig. 4 shows the PDF of wind speed datasets generated by the two UM techniques at varying sizes (100, 500, and 1000) and the reference data (indicated by the solid red line). Regarding accuracy, the observations from Fig. 4 indicate an incremental improvement in the accuracy of each UM technique as the number of generated samples increases to represent the

reference dataset. This improvement is particularly noticeable and rapid in the MC technique. This observation is anticipated since increasing the generated samples can cover the entire space, particularly for the MC, as shown in Fig. 1. This outcome can be prominently observed in Fig. 4 (1000 samples), where the two UM techniques effectively replicate the reference dataset. Additionally, this outcome is validated by calculating  $R^2$  and RMSE values, which demonstrate an increase in  $R^2$  values and a decrease in RMSE values for each technique as the number of sample generations increases, as depicted in Fig. 5.

Regarding efficiency, it is observed from Fig. 4 that the accuracy of the sampling techniques with fewer samples (100 and 500) varies across different techniques. The QMC technique shows better efficiency in illustrating the reference data than the MC technique. This finding is also verified by the  $R^2$  and RMSE values, as shown in Fig. 5. The UM technique with the highest  $R^2$  value and the lowest RMSE value is determined as a more efficient and accurate technique. This observation is reasonable due to using low-discrepancy samples in the QMC technique. These samples are uniformly distributed to cover the entire space, even with fewer samples. In comparison, the MC technique generates random number samples in a non-uniform manner across the entire space, as illustrated in Fig. 1. Consequently, the MC technique is not considered an efficient approach. It is not suitable for scenarios with fewer simulations.

Overall, the QMC technique is a more efficient UM, accurately representing the reference data. Conversely, the MC technique shows the poorest representation of the reference dataset when fewer samples are generated.

### B. Probabilistic Frequency Nadir

In order to verify the more accurate and efficient UM technique for probabilistic frequency stability analysis, the RMS simulation was conducted in DigSILENT PowerFactory software. This analysis encompassed the reference dataset comprising 8760 samples and sample datasets of varying sizes generated using MC and QMC techniques. Fig. 6 presents the PDF of the probabilistic frequency Nadir obtained from 100, 500, and 1000 simulations using MC and QMC techniques compared to the reference data. Furthermore, Fig. 7 shows the  $R^2$  and RMSE values of the probabilistic frequency Nadir for varying numbers of simulations compared with the reference dataset.

The observation of Fig. 6 confirms that the UM techniques' accuracy improves as the number of simulations increases. RMS simulation analysis uses an extensive set of wind speed datasets comprising (8760 samples) to confirm the accurate alignment of the two UM techniques with the results obtained from the reference dataset, as shown in Fig. 6 (1000 samples). This finding is also confirmed by the high  $R^2$  and low RMSE values obtained for the two UM techniques, as presented in Fig. 7. This result is consistent with the previous outcome shown in Fig. 4 and 5.

Conversely, the RMS simulation analysis was conducted for lower random sample generations (100 and 500 samples) to determine and validate the more efficient UM techniques. Fig. 6 (100, 500 samples) demonstrates that the QMC technique exhibits the nearest and adequate results that observe the reference data compared to the MC technique in Fig. 4.

On the other hand, the MC technique has a less accurate representation of the reference dataset when using fewer samples. This finding is proved by Fig. 7, where the QMC technique indicates the lowest RMSE values and highest  $R^2$  values compared to the MC technique for 100 and 500 random

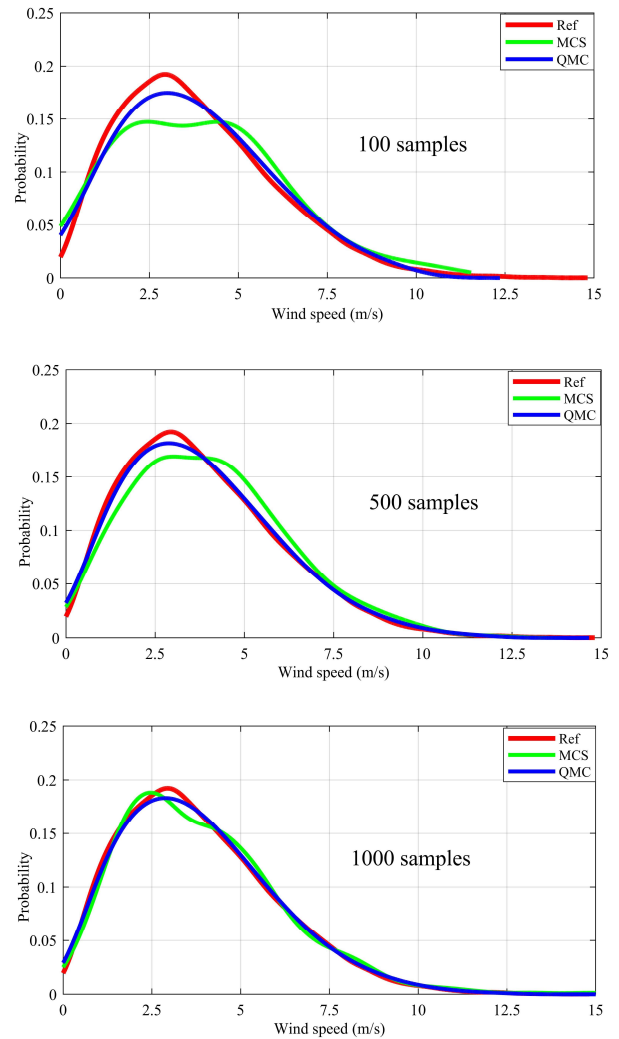

Fig. 4. The PDFs of the wind speed datasets (100, 500, and 1000 samples respectively).

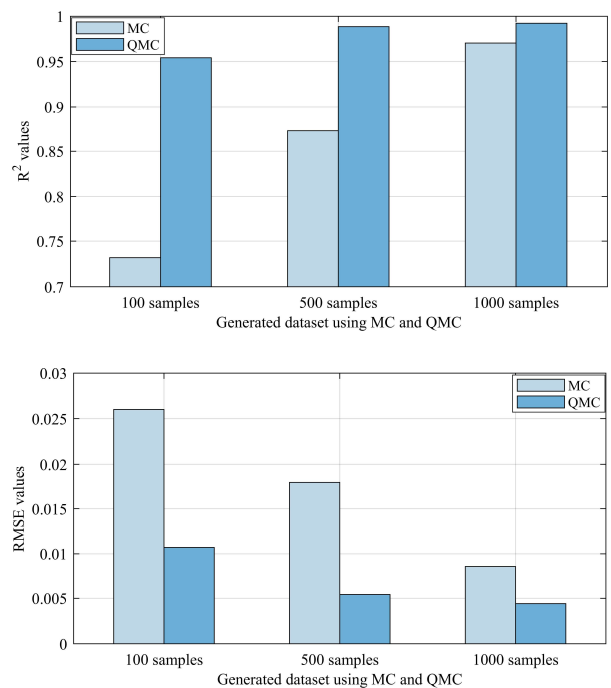

Fig. 5. The  $R^2$  and RMSE values of 100, 500, and 1000 generated wind speed samples.

samples. These results align with the  $R^2$  and RMSE values presented in Fig. 5.

The MC and QMC techniques can be used for probabilistic frequency stability analysis. However, the MC technique is unsuitable for realistic large-scale power systems due to its high computational requirements. In contrast, the QMC technique is efficient and accurate, making it well-suited for such systems.

Fig. 8, illustrates the  $R^2$  values of wind speed samples generated by the two UM techniques across different sample sizes. This comparison enables the assessment of accuracy and efficiency for each technique, aiding in selecting an appropriate technique for wind data sampling in power system frequency stability studies.

According to Fig. 8, with 100 samples, the random wind speed data generated using MC and QMC techniques exhibit 73% and 95.5% accuracy, respectively. As the number of simulations increases, the accuracies improve, reaching 86% and 98.9% for MC and QMC techniques, respectively, with 500 samples. Beyond 1000 simulations, both techniques reach near saturation, with MC achieving an accuracy of 97% and QMC achieving an accuracy of 99.5%.

Based on the results, the QMC technique outperforms the MC technique in terms of efficiency for generating wind speed data samples. Conversely, the MC technique demonstrates lower efficiency in representing the wind speed data. This observation aligns with expectations, as the QMC technique utilises low-discrepancy sequences that follow a uniform distribution for generating random samples.

In summary, from Fig. 9, an efficient UM technique exhibits notable time-saving advantages compared to conducting simulations for all 8760 samples. The QMC technique requires only 300 simulations, which can be accomplished within three minutes while maintaining an accuracy of 96.5%. In contrast, the MC technique requires 1000 simulations to achieve a similar accuracy level, taking approximately 12 minutes for completion. This significant reduction in simulation time demonstrates the efficiency and time-saving benefits of employing the QMC technique in the analysis. Notably, these simulation times are recorded for a test network, while the multitude of the simulation time will be escalated with the size of the network.

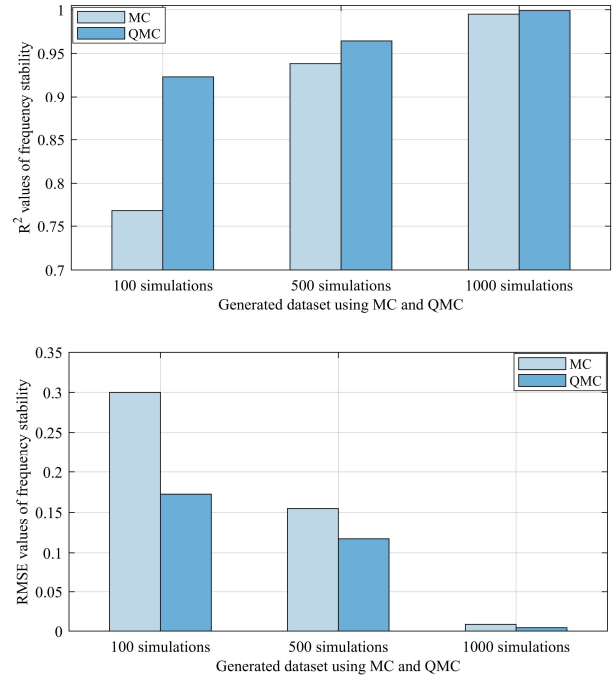

Fig. 7. The  $R^2$  and RMSE values of 100, 500, and 1000 simulations of the probabilistic frequency Nadir.

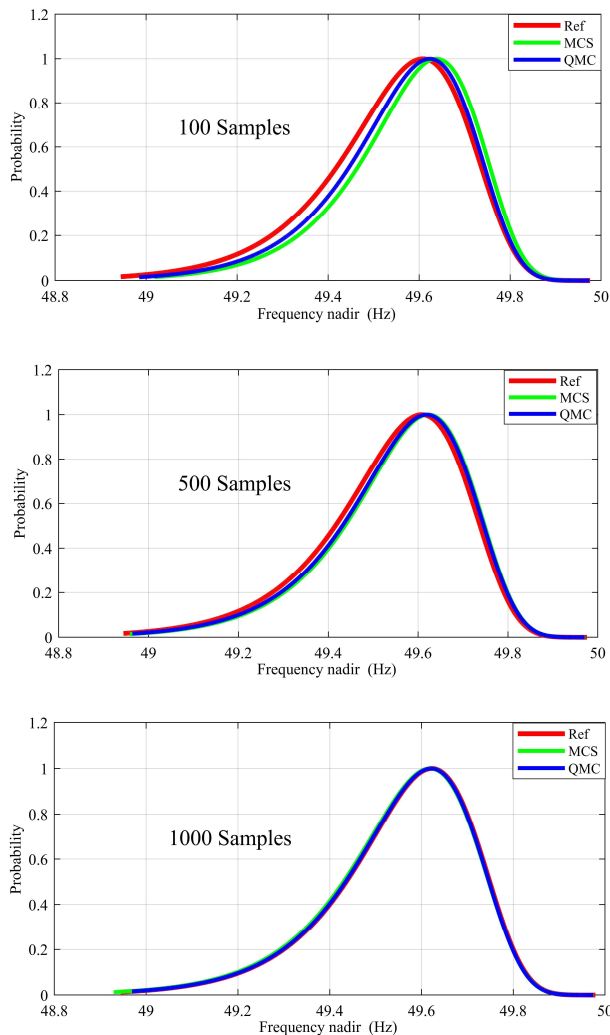

Fig. 6: The PDFs of the probabilistic frequency Nadir datasets (100, 500, and 1000 samples respectively).

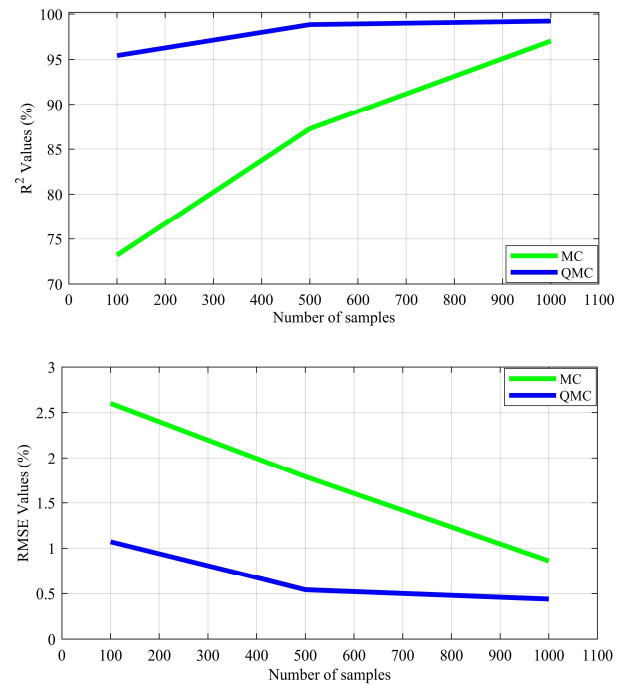

Fig. 8. The  $R^2$  and RMSE values against the sample number for the generated wind speed.

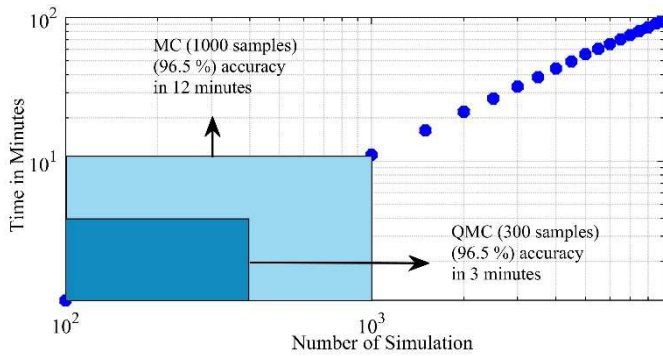

Fig. 9. The accuracy ( $R^2$ ) vs. efficiency (number of simulations and simulation time) curve of the frequency Nadir for the MC and the QMC generated data compared to the reference data.

## V. CONCLUSIONS

This study conducts a comparative analysis to evaluate accurate and efficient UM techniques for assessing their applicability for probabilistic frequency stability analysis in large-scale power systems, considering the time-consuming and computationally expensive MC technique. As a result, different UM techniques, namely MC and QMC, were implemented and compared. To verify the suitability of the more accurate and efficient UM techniques for probabilistic frequency stability analysis, RMS simulation analysis was conducted on the IEEE-39 bus network. The evaluation was based on the criteria of  $R^2$  and RMSE.

The simulation outcomes demonstrate that the accuracy of the two UM techniques improves as the random sample numbers increase in the analysis of wind speed generation. Moreover, the UM techniques perfectly align with the reference data by generating many random samples. The outcomes also have been verified by the frequency stability simulation. Finally, these outcomes show that the QMC is a more accurate and efficient technique that shows the best representation by generating fewer random samples for the reference data. It provides more than (96.5%) accuracy with fewer samples and less time (300 samples in 3 minutes), while MC requires 1000 samples and approximately 12 minutes for the same accuracy level (96.5%).

## REFERENCES

- [1] M. Xiang, J. Yu, Z. Yang, Y. Yang, H. Yu, and H. He, "Probabilistic power flow with topology changes based on deep neural network," *International Journal of Electrical Power & Energy Systems*, vol. 117, p. 105650, 2020.
- [2] B. Qi, K. N. Hasan, and J. V. Milanović, "Identification of critical parameters affecting voltage and angular stability considering load-renewable generation correlations," *IEEE Transactions on Power Systems*, vol. 34, no. 4, pp. 2859-2869, 2019.
- [3] M. Alzubaidi, K. N. Hasan, L. Meegahapola, and M. T. Rahman, "Identification of Efficient Sampling Techniques for Probabilistic Voltage Stability Analysis of Renewable-Rich Power Systems," *Energies*, vol. 14, no. 8, 2021.
- [4] K. S. Ratnam, K. Palanisamy, and G. Yang, "Future low-inertia power systems: Requirements, issues, and solutions-A review," *Renewable and Sustainable Energy Reviews*, vol. 124, p. 109773, 2020.
- [5] M. Alzubaidi, K. N. Hasan, L. Meegahapola, and M. T. Rahman, "Probabilistic Voltage Stability Analysis Considering Variable Wind Generation and Different Control Modes," in *2021 31st Australasian Universities Power Engineering Conference (AUPEC)*, 2021: IEEE, pp. 1-6.
- [6] A. Ashouri - Zadeh, M. Toulabi, A. S. Dobakhshari, and A. M. Ranjbar, "Frequency stability improvement in wind - thermal dominated power grids," *IET Generation, Transmission & Distribution*, vol. 14, no. 4, pp. 619-627, 2020.
- [7] K. N. Hasan, R. Preece, and J. V. Milanović, "Existing approaches and trends in uncertainty modelling and probabilistic stability analysis of

- power systems with renewable generation," *Renewable and Sustainable Energy Reviews*, vol. 101, pp. 168-180, 2019.
- [8] A. S. Singh and M. B. Masuku, "Sampling techniques & determination of sample size in applied statistics research: An overview," *International Journal of economics, commerce and management*, vol. 2, no. 11, pp. 1-22, 2014.
- [9] U. Diwekar and A. David, "Uncertainty Analysis and Sampling Techniques," in *BONUS Algorithm for Large Scale Stochastic Nonlinear Programming Problems*: Springer, 2015, pp. 9-25.
- [10] A. M. Hakami, K. N. Hasan, M. Alzubaidi, and M. Datta, "A Comprehensive Review of Sampling Techniques for Probabilistic Stability Analysis of Future Power Grids," in *2022 IEEE PES 14th Asia-Pacific Power and Energy Engineering Conference (APPEEC)*, 2022: IEEE, pp. 1-7.
- [11] A. M. Hakami, K. N. Hasan, M. Alzubaidi, and M. Datta, "A Review of Uncertainty Modelling Techniques for Probabilistic Stability Analysis of Renewable-Rich Power Systems," *Energies*, vol. 16, no. 1, p. 112, 2022.
- [12] V. Gevorgian, Y. Zhang, and E. Ela, "Investigating the impacts of wind generation participation in interconnection frequency response," *IEEE transactions on Sustainable Energy*, vol. 6, no. 3, pp. 1004-1012, 2014.
- [13] M. Alzubaidi, K. N. Hasan, and L. Meegahapola, "Impact of Probabilistic Modelling of Wind Speed on Power System Voltage Profile and Voltage Stability Analysis," *Electric Power Systems Research*, vol. 206, 2022.
- [14] R. Preece and J. V. Milanović, "Efficient estimation of the probability of small-disturbance instability of large uncertain power systems," *IEEE Transactions on Power Systems*, vol. 31, no. 2, pp. 1063-1072, 2015.
- [15] J. Bhukya, N. Kumar Singh, and V. Mahajan, "Impact of aggregated model-based optimization for wind farm and electric vehicle on power system stability," *Computers and Electrical Engineering*, vol. 105, p. 108480, 2023.
- [16] J. Zhang, C. Tse, W. Wang, and C. Chung, "Voltage stability analysis based on probabilistic power flow and maximum entropy," *IET generation, transmission & distribution*, vol. 4, no. 4, pp. 530-537, 2010.
- [17] R. Preece, N. C. Woolley, and J. V. Milanović, "The probabilistic collocation method for power-system damping and voltage collapse studies in the presence of uncertainties," *IEEE Transactions on Power Systems*, vol. 28, no. 3, pp. 2253-2262, 2012.
- [18] A. Schellenberg, W. Rosehart, and J. A. Aguado, "Cumulant-based stochastic nonlinear programming for variance constrained voltage stability analysis of power systems," *IEEE Transactions on power systems*, vol. 21, no. 2, pp. 579-585, 2006.
- [19] S. Impram, S. V. Nese, and B. Oral, "Challenges of renewable energy penetration on power system flexibility: A survey," *Energy Strategy Reviews*, vol. 31, p. 100539, 2020.
- [20] H. Alsharif, M. Jalili, and K. N. Hasan, "Power system frequency stability using optimal sizing and placement of Battery Energy Storage System under uncertainty," *Journal of Energy Storage*, vol. 50, p. 104610, 2022.
- [21] E. Rakhshani, D. Gusain, V. Sewdien, J. L. Rueda Torres, and M. A. M. Van Der Meijden, "A Key Performance Indicator to Assess the Frequency Stability of Wind Generation Dominated Power System," *IEEE Access*, vol. 7, pp. 130957-130969, 2019.
- [22] H. Alsharif, M. Jalili, and K. N. Hasan, "Fast frequency response services in low inertia power systems—A review," *Energy Reports*, vol. 9, pp. 228-237, 2023.
- [23] H. Huang, C. Chung, K. W. Chan, and H. Chen, "Quasi-Monte Carlo based probabilistic small signal stability analysis for power systems with plug-in electric vehicle and wind power integration," *IEEE Transactions on Power Systems*, vol. 28, no. 3, pp. 3335-3343, 2013.
- [24] B. Zou and Q. Xiao, "Solving probabilistic optimal power flow problem using quasi Monte Carlo method and ninth-order polynomial normal transformation," *IEEE Transactions on Power Systems*, vol. 29, no. 1, pp. 300-306, 2013.
- [25] M. Renardy, L. R. Joslyn, J. A. Millar, and D. E. Kirschner, "To Sobol or not to Sobol? The effects of sampling schemes in systems biology applications," *Mathematical biosciences*, vol. 337, p. 108593, 2021.
- [26] S. Joe and F. Y. Kuo, "Remark on algorithm 659: Implementing Sobol's quasirandom sequence generator," *ACM Transactions on Mathematical Software (TOMS)*, vol. 29, no. 1, pp. 49-57, 2003.
- [27] S. A. Akdağ and A. Dinler, "A new method to estimate Weibull parameters for wind energy applications," *Energy conversion and management*, vol. 50, no. 7, pp. 1761-1766, 2009.
- [28] M. Pai, *Energy Function Analysis for Power System Stability*. Springer Science & Business Media, 2012.
- [29] M. Office, "Met Office MIDAS Open: UK Land Surface Stations Data (1853-Current)," *Centre for Environmental Data Analysis, Date of Citation*, 2019.
- [30] M. Negnevitsky, D. H. Nguyen, and M. Piekutowski, "Risk assessment for power system operation planning with high wind power penetration," *IEEE Transactions on Power Systems*, vol. 30, no. 3, pp. 1359-1368, 2014.